

Installation and connection of web drive POL909.50

General

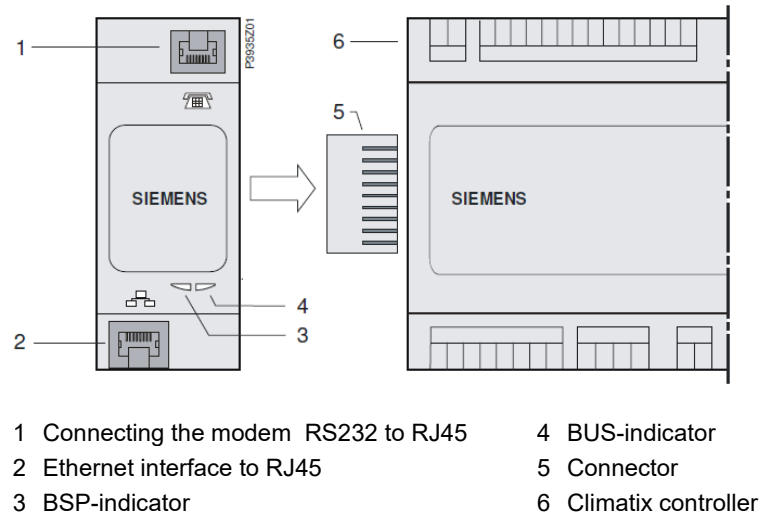

Installation

Install the Web drive as follows:

1. Disconnect the power to the controller.
2. Connect POL909.50 (Web drive) as illustrated. Make sure the web drive is firmly fitted against the controller. The distance between the controller and Web drive should not exceed 1 mm.
3. Turn on the power to the controller
4. BSP indicator will turn orange for half a minute and then turn green, then the BUS indicator will turn orange for a minute before switching to green.
5. Log on to the HMI with password: 2000.
6. Go to: *main index_System overview_Communication_Comm module overview.*

Here it should now be displayed: Module 1 WEB OK and Com.module Modified OK.

If it does not, then do a restart (menu line 1 of the display). When it displays OK on both lines there should be a green light on both the LED indicators on the module.

Setting

Settings of the Web drive is in:
main index_ *System overview_ Communication_ Comm module overview.*

1. set *DHCP_Passive*.
2. Set IP. Enter the IP address that the unit will have to connect to the network.
NOTE! If all 12 fields are filled in with numbers, you have to exit the field with #.
3. Set the subnet Mask. Enter the Subnet Mask of the unit will have to connect to the network.
NOTE! If all 12 fields are filled in with numbers, you have to exit the field with #.
4. Set Gateway. Enter the Gateway unit will have to connect to the network. NOTE! If all 12 fields are filled in with numbers, you have to exit the field with #.
5. Save settings. Set Write settings to: Active.
6. Restart required ! Execute
7. Connect the network cable into the network jack on the module (item 2 in the figure).

When both the BSP and the BUS indicator turn green again, the unit should be ready to connect to via a networked PC.

Enter IP address in the address bar of the browser.

User Level:

User name: USER
Password: user

Expert level:

User name: AWMADMIN
Password: awmadmin