

Connection instructions

Air treatment unit

Electrical and control equipment

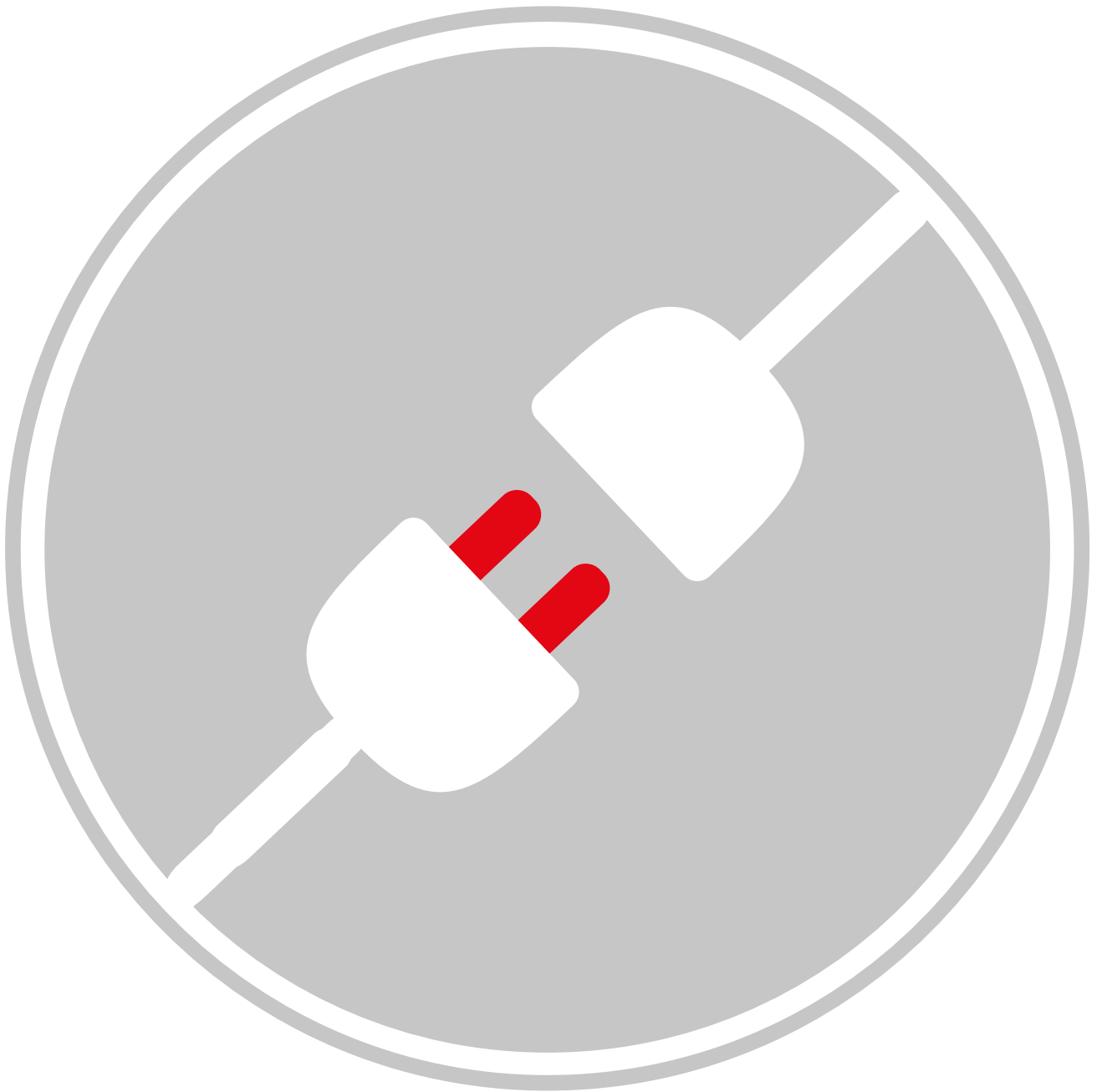



Documentation for your unit

1. Go to *docs.ivprodukt.com* (Order Portal) or scan the QR code.
2. Enter your order number.
3. Press ENTER or click on search.
4. Select your order.

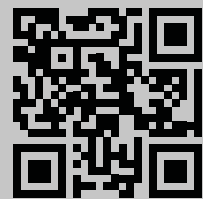

Order Portal

Is any documentation missing?

See information in section

"Documentation for your unit", page 2.

TABLE OF CONTENTS

1	SAFETY	5
1.1	Intended use	5
1.2	Unintended uses	5
1.3	General safety	5
1.4	Structure of alert messages	6
1.5	General warning notices	6
1.6	Signs on the unit	6
1.6.1	Safety symbols, signs on the unit	6
1.6.2	Nameplates	6
1.7	Product liability	7
1.8	After the product lifetime expiry	7
2	GENERAL INFORMATION	8
2.1	Documentation and support	8
2.2	Information messages, not safety-related	8
2.3	Spare parts	8
2.4	Terms and abbreviations used in the manual	8
2.5	Symbols on dimension drawings and in the manual	8
2.6	Signs/markings on the unit	9
3	DESCRIPTION OF THE UNIT	10
3.1	Configuration of the unit	10
3.2	Orientation of the unit's sides/parts	10
3.3	Quick connectors	10
3.3.1	Quick connector, signal feed	10
3.3.2	Quick connector, power supply	10
4	CONTROL EQUIPMENT	11
4.1	Flexomix	11
4.2	Envistar Flex, Envistar Top, Envistar Compact, EcoHeater	11
4.3	Electrical wiring diagrams and drawings	12
4.4	Unit with control equipment	12
4.4.1	Fuse protection, power supply, safety switch	12
4.4.2	Unit with control equipment	13
4.4.3	Unit with control equipment UC	13
4.4.4	Unit with control equipment MK	13
4.4.5	Unit with control equipment HS	13
4.4.6	Unit with control equipment US	13

Connection instructions

Air treatment unit

5	ELECTRICAL CONNECTION	14
5.1	Fan.....	14
5.2	Rotary heat exchanger	14
5.2.1	Connection of rotor drive	15
5.3	Cross-flow heat exchanger.....	15
5.4	Counter-flow heat exchanger with defrost protection (ODS).....	15
5.5	Counter-flow heat exchanger with frost protection (BYP).....	15
5.6	Battery heat exchanger	16
5.7	Cooling heat pump and cooling unit.....	16
5.8	Air heater electric.....	16
5.8.1	Connection electrical air heater	17
5.9	Evaporative humidifier.....	17
5.10	Damper actuator	17
5.11	Valve actuator.....	18
5.12	Temperature sensors.....	18
5.13	Pressure sensors	18
5.14	Other sensors.....	18
5.15	LED lighting in the unit (optional)	18
5.16	Fan connection, post-delivery of fan.....	19

1 SAFETY

This section addresses important safety aspects of assembly, with the aim of raising safety awareness and avoiding personal injuries and damage to surroundings and units. For commissioning of units, see Operation and care for each unit or unit part.



- This manual contains important instructions. Read it carefully and follow the instructions.
- Pay special attention to warning and information messages, as well as markings on the product.
- Keep the manual for future use.

00177

1.1 Intended use

Intended use

The product is intended to be used air handling unit for comfort ventilation in properties.

Intended users

The contents of this manual are intended for qualified electricians who install electrical and control equipment and electrically connect the unit.

1.2 Unintended uses

Any use other than specified in Intended use is prohibited unless specifically permitted by IV Produkt. It is not permitted to use the unit in potentially explosive environments.

1.3 General safety



WARNING!

Risk of life-threatening or serious personal injury.

Electrical voltage can cause electric shock, burns and death. The product must not be energised during assembly.

- Electrical connection and electrical work may only be carried out by a qualified electrician.
- For initial start-up of the unit, see Operation and Maintenance of the unit on IV Produkt's order portal.

00176

Failure to comply with the safety precautions may result in injury to persons or damage to air handling units. To avoid personal injuries and damage to surroundings or units:

- Follow national and local laws/regulations for safe work, e.g. fall protection when working at a height.
- Do not wear loose clothing or jewellery that may become fastened.
- Do not step or climb on the unit.
- Use appropriate tools.
- Use appropriate personal protective equipment.
- Note the unit's markings: product signs, information and warning stickers.

Personal Protective Equipment (PPE)

Personal protective equipment must always be used based on the risks present in the workplace. For example, wear protective footwear with steel toecaps, hearing protection, safety helmet, gloves, safety eyewear or goggles, fully-covering clothing, safety overalls, mouth-guard/protective mask and/or fall protection where the work and work environment requires it.



Connection instructions Air treatment unit

1.4 Structure of alert messages

Warning notices in the instruction warn of risks when handling and assembling the product. Carefully follow the instructions published in warning notices.



The warning symbol indicates that a risk exists.

WARNING! indicates a potential risk that, if not avoided, can cause **life-threatening or serious** situations that can lead to death or personal injury.

CAUTION! indicates a potential risk that, if not avoided, could cause **material damage** to the product or surroundings as well as impairment of product function.

“**Risk of xxxxxx.**” indicates the risk in a short risk title.

A description in italics provides more detailed information about what the risk entails.

- The bullet points indicate how the user avoids harm.

1.5 General warning notices



WARNING!

Risk of life-threatening or serious personal injury.

Electrical voltage can cause electric shock, burns and death. The product must not be energised during assembly.

- Electrical connection and electrical work may only be carried out by a qualified electrician.
- For initial start-up of the unit, see Operation and Maintenance of the unit on IV Produkt's order portal.

00176

1.6 Signs on the unit

1.6.1 Safety symbols, signs on the unit

Keep signs and stickers free of dirt. Replace missing, damaged or unreadable signs and stickers on the machine. Contact IV Product for replacement stickers by specifying the article number.

1.6.2 Nameplates

The unit and any associated cooling unit/reversible heat pump have a type plate affixed to the front. The type plate is used, among other things, for identification of the product.



00043

Figure: Example of a unit type plate

- | | |
|-----------------------|-------------------------|
| 1. Order number | 5. Place of manufacture |
| 2. Product name/model | 6. Date of manufacture |
| 3. Product code | 7. QR code |
| 4. Unit designation | |

1.7 Product liability



CE marking (EU) and UKCA marking (UK)

[IV Produkt's order portal](#) The air handling unit is CE and UKCA marked and meets the applicable requirements according to specified directives and standards in the Declaration of Conformity. The marking covers the unit in the design in which it was delivered and provided that it has been assembled and commissioned in accordance with IV Produkt's instructions. The declaration does not cover assemblies that have been modified, components that have subsequently been added or other plants in which the unit may be included. The unit may not be put into service until the plant in which it is included complies with the requirements for CE-marking.

The EC Declaration of Conformity can be found at [IV Produkt's order portal](#). See "[Documentation for your unit](#)", page 2.

Manufacturer

The air handling unit is manufactured by:

IV Produkt AB, Sjöuddevägen 7, S-350 43 Växjö, Sweden

Warranty

For adequate operation and for warranty to apply, these instructions must be followed, and properly performed commissioning done, see Operation and Care for each unit.

Disclaimer

Continuous product development may give rise to specification changes without notice.

1.8 After the product lifetime expiry

For dismantling and decommissioning the air handling unit, see Operation and Maintenance.



Connection instructions Air treatment unit

2 GENERAL INFORMATION

2.1 Documentation and support

The documentation for your unit can be found in the Order Portal. See "[Documentation for your unit](#)", page 2.

It can take up to two weeks for all documentation to be available in the Order Portal. The text "Documentation in progress" appears until the documentation is complete. In case of missing or incorrect documentation, contact DU/Documentation. For other support, please contact the department to which the case relates. See contact details on the last page of the manual.

2.2 Information messages, not safety-related

	Symbol together with information text highlights difficulties and also gives tips and recommendations.	00182
--	--	-------

2.3 Spare parts

Spare parts list can be found in the Order Portal. Order spare parts and accessories from IV Produkt. See contact details on the last page of the manual. When contacting, state the order number and unit designation from the nameplate, located on the unit.

2.4 Terms and abbreviations used in the manual

Block configuration	Units are supplied as separate unit parts.
One-piece configuration	The unit is delivered pre-assembled as a unit.

2.5 Symbols on dimension drawings and in the manual

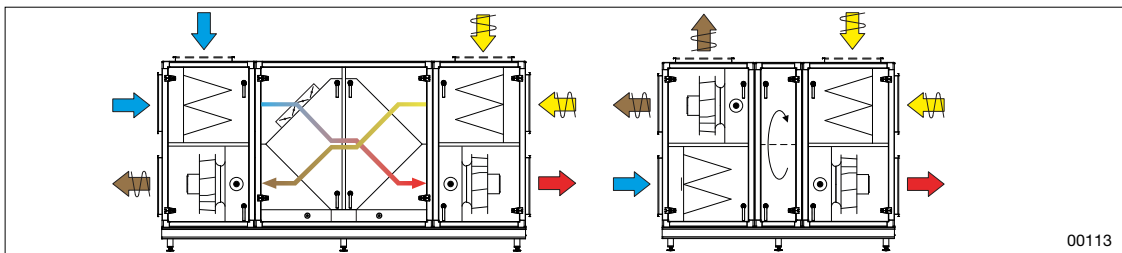

Figure: Example of a layout drawing

	Outdoor air		Extract air
	Supply air		Exhaust air
	Fan		Filter

Connection instructions Air treatment unit



	Shut-off damper		Trim damper
	Cooling coil water		Heating coil water
	Heating coil electric		Sound attenuator
	Rotary heat exchanger		Cross-flow heat exchanger
	Counter-flow heat exchanger		Compressor
	Cooling unit		Quick connector
	Media section		

2.6 Signs/markings on the unit

All parts are marked with stickers that show what function the part has.

	Filter		Smoke by-pass
	Rotary heat exchanger		Air turner
	Plate heat exchanger		Smoke by-pass from above
	Fan		Media
	Air cooler water		Empty
	Air heater liquid		Humidifier
	Air heater electric		Angle
	Damper		Inspection section
	Noise attenuator		Temperature sensors
			Earth



Connection instructions Air treatment unit

3 DESCRIPTION OF THE UNIT

3.1 Configuration of the unit

The unit can be supplied with or without control and adjustment equipment. See "[4 CONTROL EQUIPMENT](#)", page 11.

3.2 Orientation of the unit's sides/parts

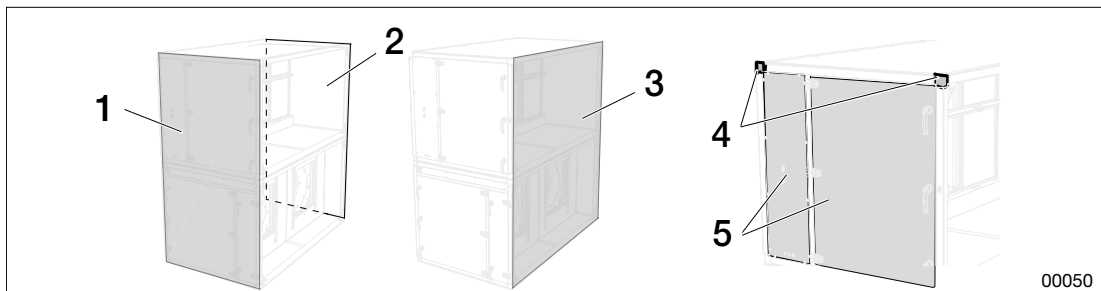

Figure: Parts of the unit

- | | |
|----------------|-------------------|
| 1. Access side | 4. Corner fitting |
| 2. Back | 5. Covers |
| 3. Gable side | |

3.3 Quick connectors

Quick connectors to be joined are marked with the same designation.

3.3.1 Quick connector, signal feed

1. Press together quick connectors according to marking (arrows or other).

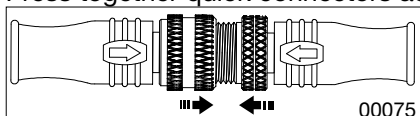

2. Screw together as hard as possible by hand.



3.3.2 Quick connector, power supply

1. Press together quick connectors according to marking (arrows, dashes or similar).

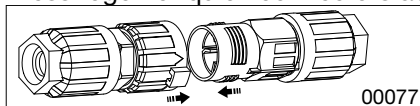

2. Turn the arrow on the white cuff to the mark for closed (padlock).

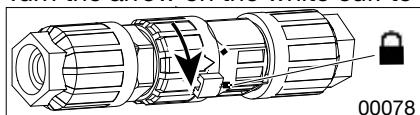

4 CONTROL EQUIPMENT



WARNING!

Risk of life-threatening or serious personal injury.

Electrical voltage can cause electric shock, burns and death. The product must not be energised during assembly.

- Electrical connection and electrical work may only be carried out by a qualified electrician.
- For initial start-up of the unit, see Operation and Maintenance of the unit on IV Produkt's order portal.

00176

IV Produkt provides control equipment for the unit series Envistar Flex, Envistar Top, Envistar Compact and Flexomix. The unit series Flexomix is supplied without control equipment.

For more information and for available options of control equipment for the aggregate series Envistar Flex, Envistar Top and Envistar Compact, see ["4.2 Envistar Flex, Envistar Top, Envistar Compact, EcoHeater", page 11](#). For Flexomix, see ["4.1 Flexomix", page 11](#). For important product data and identification of units, see the nameplate on each unit part.

4.1 Flexomix

Flexomix supplied without control and without electrical connections. The customer is responsible for connection of the unit to suitable control equipment and is responsible for ensuring that the unit, after connection, meets the applicable requirements for CE marking in its entirety, as a completed machine.

For supplementary information about electrical connection, see ["5 ELECTRICAL CONNECTION", page 14](#) and the order-specific Operation and Maintenance in the [IV Produkt order portal](#), ["Documentation for your unit", page 2](#).

4.2 Envistar Flex, Envistar Top, Envistar Compact, EcoHeater

MX	The unit is delivered electrically connected internally, with complete integrated control equipment.
UC	The unit is supplied without a processor unit but with fans, heat exchanger, sensors and damper actuators electrically connected to the terminal block. The terminal block is located in the control cabinet / media part. Fans and heat exchangers are internally secured.
MK	The unit is supplied with fans and heat exchangers electrically connected to terminal block. In the unit version of Envistar Top and Envistar Compact, size 04, 06, 10, the terminal blocks are located in the media part. Units in outdoor versions have terminal blocks placed in the fan / media part. In the other units, the terminals are located externally, on the respective unit part.
HS	The unit is delivered without control equipment and without electrical connection, but with defrosting automatics for the heat exchanger.
US	Units are supplied without control equipment and without electrical connections.



Connection instructions

Air treatment unit

4.3 Electrical wiring diagrams and drawings

Download current (order-unique) drawings and control diagrams from [IV Produkt's order portal](#), "[Documentation for your unit](#)", [page 2](#).

4.4 Unit with control equipment

For electrical connection of units see control diagram on [IV Produkt's order portal](#), "[Documentation for your unit](#)", [page 2](#).

4.4.1 Fuse protection, power supply, safety switch



A residual electrical current breaker (ECBL) should not be used since the unit has a built-in frequency inverter. If a residual current circuit breaker is used, we recommend a 300 mA, type B residual current circuit breaker specially adapted for the frequency inverter. It is then intended as fire protection and not for personal protection.

The recommended size of fuse according to control diagram and Technical data refers to fuses with C-characteristics. The following tables show the requirements for power feeds for the unit series and whether safety switches are supplied. In cases where units are supplied without a safety switch, the units must always be supplemented with the necessary safety switches.

Envistar Flex	MX	UC	MK	HS	US
Safety switch mounted on/in an electrical cabinet ¹	√	√	-	-	-
One power supply per unit ²	-	-	-	-	-
Multiple power feeds per unit ³	√	√	√	√	√

Envistar Top	MX	UC	MK	HS	US
Safety switch mounted on/in an electrical cabinet ¹	-	-	-	-	-
One power supply per unit ^{2, 4}	√	√	-	-	-
Multiple power feeds per unit ³	-	-	√	√	√

Envistar Compact	MX	UC	MK	HS	US
Safety switch mounted on/in an electrical cabinet ¹	-	-	-	-	-
One power supply per unit	-	-	-	-	-
Multiple power feeds per unit ³	√	√	√	√	√

EcoHeater	MX	UC	MK	HS	US
Safety switch mounted on/in an electrical cabinet ¹	√	NA	NA	NA	NA

1. If the unit has been ordered without a safety switch, the customer is responsible for the required number of safety switches, connection, assembly and fuse. Safety switches are available as an option Envistar Top (Envistar Compact MX, UC).
2. The unit has a common power supply that feeds all the unit functions.

3. The unit has a number of power feeds depending on the configuration. MX, UC: The unit's basic functions in the form of fans, heat exchangers and control systems have a common power supply. MK, HS, US: Each unit part is connected to a separate power supply. Cooling machine, heat pump and air heater electricity require separate power feeds. For 230 V, air heater electricity in a special version or transformer is required.
4. Envistar Top available in a special version that requires separate power feeds (for example, in the case of all-pole breakers).

4.4.2 Unit with control equipment

Unit in unit version

The unit is delivered electrically connected internally, with complete integrated control equipment.

Block units

The unit should, after assembly, be connected using quick contacts, "[3.3 Quick connectors](#)", [page 10](#).

4.4.3 Unit with control equipment UC

The unit is supplied without a processor unit but with fans, heat exchanger, sensors and damper actuators electrically connected to terminal blocks in electrical cabinets/media parts. Fans and heat exchangers are internally secured.

The unit should, after assembly, be connected using quick contacts, "[3.3 Quick connectors](#)", [page 10](#).

4.4.4 Unit with control equipment MK

The unit is supplied with fans and heat exchangers electrically connected to terminal blocks.

In the unit version of Envistar Top and Envistar Compact, size 04, 06, 10, the terminal blocks are located in the media part.

In the other units, the terminal blocks are located externally, on the respective unit part.

4.4.5 Unit with control equipment HS

The unit is delivered without control equipment and without electrical connections, but with defrosting automatics for the heat exchanger. Air flow sensors for the exhaust fan (included in the function of the automatic unit) are supplied mounted and must be connected via quick connectors to the automatic unit. The automatic unit is located on/in the heat exchanger in the block design.

Units with rotating heat exchangers in HS design also have a regulating damper actuator placed on the damper in the exhaust air. The damper actuator must be connected to the automatic unit, with quick connectors, "[3.3 Quick connectors](#)", [page 10](#).

4.4.6 Unit with control equipment US

Units are supplied without control equipment and without electrical connections.



Connection instructions Air treatment unit

5 ELECTRICAL CONNECTION

For each unit part's connection (external connection, power supply and safety switch), see the unit parts' connection pictures in the product selection program IV Produkt Designer, order-unique Operation and Maintenance as well as current order-unique drawings and control diagrams on [IV Produkt's order portal](#), "[Documentation for your unit](#)", [page 2](#). See also the respective part's nameplate. See also supplementary information in this section.

If the unit part/unit function is not delivered connected, the customer is responsible for the connection. The connection of the cabling must be done by a qualified electrician. No permission is needed to connect any quick connectors, "[3.3 Quick connectors](#)", [page 10](#).

5.1 Fan

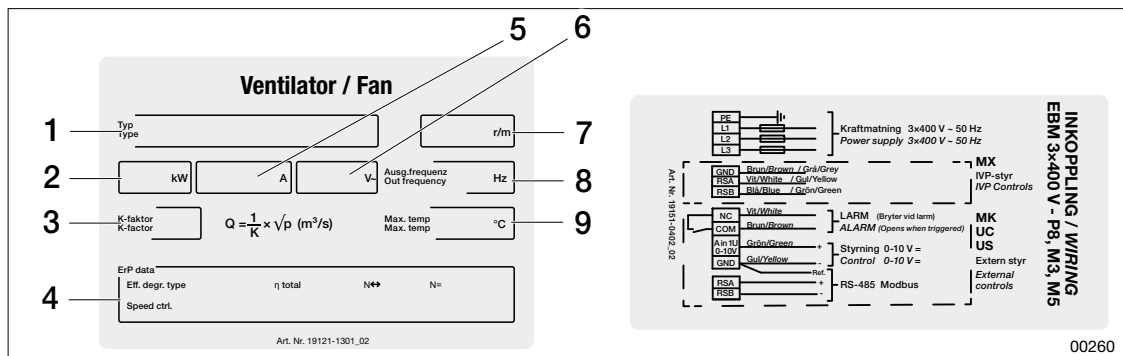

Figure: Example nameplate and label showing electrical connection

- 1. Fan type
- 2. Output (kW)
- 3. K-factor
- 4. ErP data
- 5. Current (A)
- 6. Voltage (V)
- 7. Revolutions per minute (rpm)
- 8. Frequency (Hz)
- 9. Max motor temperature (C°)

MX, UC, MK: See "[4.4.2 Unit with control equipment](#)", [page 13](#), "[4.4.3 Unit with control equipment UC](#)", [page 13](#) and "[4.4.4 Unit with control equipment MK](#)", [page 13](#).

5.2 Rotary heat exchanger

The rotary heat exchanger is supplied by an internally electrical connection between the drive motor and the rotor control unit. See also "Rotor control instructions for use".

MX: Connect the rotating heat exchanger and control cabinet/media section, with quick connectors. The rotating heat exchanger in Envistar Top sizes 04,06,10 and Envistar Compact is electrically connected to the control cabinet / media section.

MK, UC: Connect the power supply to the intended terminal block in the rotor plinth connection/control cabinet/media section, (control cable 0-10 V, as well as cabling to any other functions).

HS: Units with rotating heat exchangers also have a regulating damper actuator placed on the damper in the exhaust air. Connect the Damper actuator connection to the automatic unit, using quick connectors.

US (Power units without control equipment and assembly series Flexomix): Connect the power supply of the intended terminal block in the rotor control unit, 0-10 V, as well as cabling to any other functions.

5.2.1 Connection of rotor drive

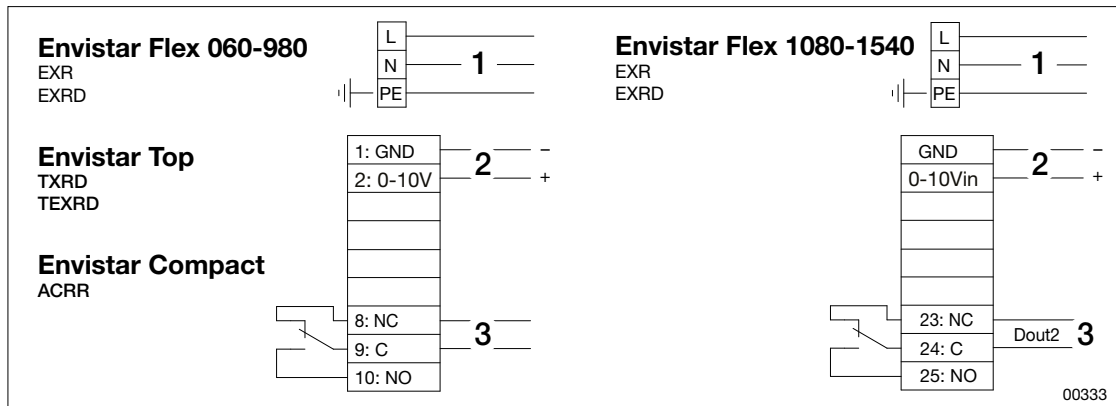

Figure: Wiring diagram rotor drive, OJ Electronics

1. Supply 1 x 230V~50Hz
2. Control
3. Alarm (closed in the event of alarm)

5.3 Cross-flow heat exchanger

MX, UC: Connect the rotating heat exchanger and control cabinet/media part, using quick connectors.

MK Damper actuators and "cold corner" temperature sensors are not included in the delivery.

US (Power units without control equipment and assembly series Flexomix): Damper actuators and "cold corner" temperature sensors are not included in the delivery.

5.4 Counter-flow heat exchanger with defrost protection (ODS)

MX: Connect the counter-flow heat exchanger and control cabinet/media part, using quick connectors.

HS, MK, UC: The damper actuator must be connected to the automatic unit, using quick connectors, On units delivered in block versions, the automatic unit is located on / in the heat exchanger. For UC; also connect the automatic unit and control cabinet / media part using quick connectors.

5.5 Counter-flow heat exchanger with frost protection (BYP)

MX, UC: Connect the counter-flow heat exchanger and control cabinet/media part, using quick connectors.

MK: Mounted "cold corner" temperature sensor and damper actuators are included electrically connected to the junction box.

US (Unit without control equipment and assembly series Flexomix): "Cold corner" temperature sensors and damper actuators, are mounted and connected to the junction box.



Connection instructions Air treatment unit

5.6 Battery heat exchanger

Envistar Flex with control equipment - MX, UC: Freezing sensors are delivered in a separate package, not connected. Fuse protection is located on the terminal block in the unit's control cabinet / media section.

Envistar Flex with control equipment types MK, US and the aggregate series Flexomix: Freezing sensors are not included. The battery heat exchanger shall be fitted with the necessary control equipment. Not included in delivery from IV Produkt.

Valve actuators and overcurrent protection for the pump are available as accessories for Envistar Flex.

5.7 Cooling heat pump and cooling unit

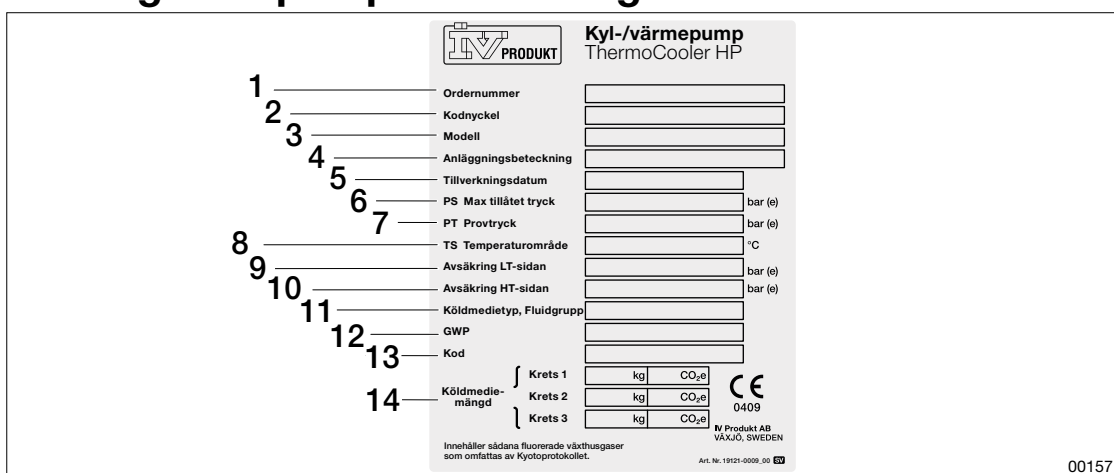

Figure: Example nameplate ThermoCooler HP

- | | |
|-------------------------------------|---|
| 1. Order number | 8. TS Temperature range, °C |
| 2. Kodnyckel | 9. Fuse LT side, bar (e) |
| 3. Model | 10. Fuse HT side, bar (e) |
| 4. Plant designator | 11. Refrigerant Type, Fluid Group |
| 5. Date of manufacture | 12. GWP |
| 6. PS Max allowed pressure, bar (e) | 13. Code |
| 7. PT Pressure test, bar (e) | 14. Refrigerant volume, Circuit 1, 2, 3 (kg, CO ₂ e) |

Envistar Flex: Cooling heat pump and cooler unit are supplied with internal electrical connections from the factory, but require separate power supply.

Envistar Top: Units are supplied with joint power feed except in the case of all-pole breakers.

Envistar Compact: The StarCooler chiller is supplied with internal electrical connections from the factory, but requires a separate power source.

The unit and chiller are prepared for 3 x 400 V+N, 50 Hz and 5-cable systems. Dimensioned short-circuit current is maximum IK3 (6 kA).

5.8 Air heater electric

Power supply

Air heaters to Envistar Flex and Envistar Compact in all designs require separate power supply.

Air heaters electricity to Envistar Top have a common power supply with the unit. The exception is air heater electrics at 230 V, for larger power consumption, for duct-mounted batteries and when there are requirements for all-pole switches. For recommended fuses in the event of these exceptions, see Technical Data.

Control signal, control and alarm.

Air heater electricity for duct assembly and air heater electricity mounted in units:

Connect control signal 0-10 V, control 230 V AC and alarm connector from the intended terminal block in the control cabinet / media section to the air heater terminal block.

Air heater electricity mounted in outdoor units: Comes with electrically connected control signal 0-10 V, control 230 V AC and alarm contact.

For more information on mounting/connecting electric batteries, see also the wiring diagram located in the air heater connection compartment.

5.8.1 Connection electrical air heater

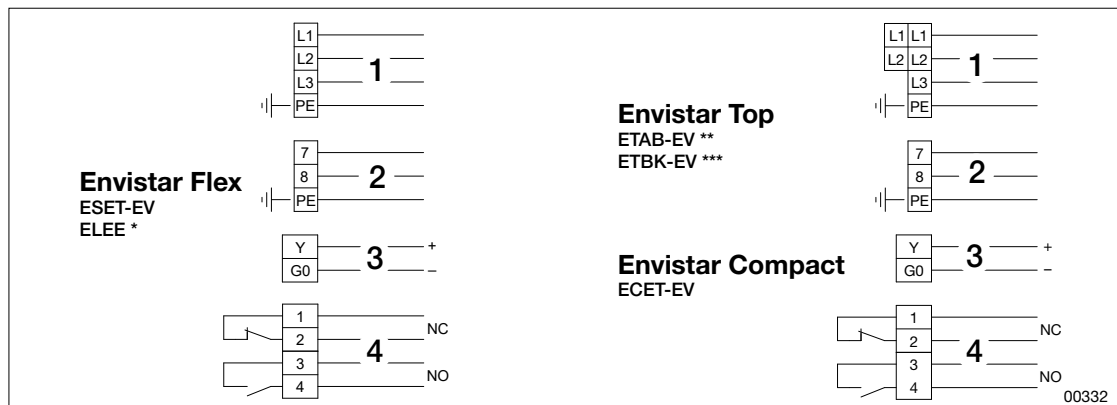

Figure: Wiring diagram, electrical air heater

- | | |
|----------------------|--|
| 1. Supply | 3. Control 0-10 V |
| 2. Control 1 x 230V~ | 4. Alarm (closed between 3 and 4 in case of alarm) |

* With integrated control equipment (ELEE-xxx-HS).

** For unit mounting, selectable for counter-flow exchanger and rotary heat exchanger.

*** For duct mounting, selectable for counter-flow exchanger

5.9 Evaporative humidifier

Humidifiers are available in several different designs and with different accessories.



Connection instructions

Air treatment unit

5.10 Damper actuator

Envistar Flex, Envistar Top, Envistar Compact (MX, UC): Damper actuators are prepared for electrical connection.

Envistar Flex size 360-600, 1250, 1540, when placed on a damper on a part other than a Fan/filter part: Connect the damper actuators to the intended terminal block in the control cabinet / media section.

Other sizes are prepared with electrical connection to damper actuators, Connect using quick connectors.

Envistar Flex, Envistar Top, Envistar Compact, Flexomix (MK, US): Dampers are normally mounted on the unit section, but not equipped with damper actuators and not electrically connected. The dampers can also be packed separately at the time of delivery and must then first be mounted on the unit and then equipped with a suitable damper actuator. Separately supplied damper actuators (KJST-04) can be ordered as accessories. The customer is responsible for electrical connection.

5.11 Valve actuator

Envistar Flex, Envistar Top, Envistar Compact (MX, UC): Valve actuators are supplied separately and are not electrically connected. Connect the damper actuators to the intended terminal block in the control cabinet / media section.

Envistar Flex, Envistar Top, Envistar Compact (MK, US): Valve actuators are supplied separately and are not electrically connected. Valve actuators can be ordered as accessories.

5.12 Temperature sensors

Envistar Flex and Envistar Compact: Temperature sensors are normally mounted and electrically connected. However, anti-freeze sensors are supplied for heating batteries and room sensors are packed separately.

Envistar Top: Anti-freeze sensors are mounted.

Supply air temperature sensors are supplied plugged in with extended cabling. Place the sensor in the duct system, at the appropriate location for good measurement conditions and control/regulation.

5.13 Pressure sensors

Temperature sensors are normally mounted and electrically connected. Place the sensor in the duct system, at the appropriate location for good measurement conditions and control/regulation.

5.14 Other sensors

For current sensors, see the control diagram on [IV Produkt's order portal](#), "[Documentation for your unit](#)", [page 2](#).

5.15 LED lighting in the unit (optional)

The lighting is mounted in the ceiling of the unit with the connecting cable attached to the lamp. IV Produkt recommends external, separate supply of the lamp in order for the lighting to turn on even when the power to the unit is turned off. For cable entry, a hole must be drilled, in a suitable place, through the unit. The lamp (5.3 W) is for connection to 230 V.

5.16 Fan connection, post-delivery of fan

MX, UC and MK: The unit is prepared with quick connectors.

MX: The fan is supplied with quick connectors. The fan's quick connectors are connected to the quick connectors mounted in the unit.

UC, MK: The unit is prepared for connecting the fan. Oncoming cabling for connection to the fan unit is supplied in the unit / fan compartment (connected to the terminal block in the terminal box / media section). Connection of the quick connection cabling on the fan unit should be done by a qualified electrician. See order-unique control diagrams in the [IV Produkt's order portal](#), "[Documentation for your unit](#)", [page 2](#).

Other units: Fan is supplied without electrical connection and without cabling.

You are welcome to contact us



IV Produkt AB, Sjöuddevägen 7, S-350 43 Växjö, Sweden
+46 470 – 75 88 00
www.ivprodukt.se, www.ivprodukt.com
www.ivprodukt.no, www.ivprodukt.dk, www.ivprodukt.de



Support:

Control:	+46 470 – 75 89 00, styr@ivprodukt.se
Service:	+46 470 – 75 89 99, service@ivprodukt.se
Spare parts:	+46 470 – 75 86 00, reservdelar@ivprodukt.se
DU/Documentation:	+46 470 – 75 88 00, du@ivprodukt.se
