



# Operation and maintenance

**EcoHeater**

**Size 060-300**



Order number:

Project name:





## Documentation for your unit

1. Go to IV Produkt's order portal, [docs.ivprodukt.com](https://docs.ivprodukt.com) or scan the QR code.
2. Enter your order number.
3. Press ENTER or click search.
4. Select your order.

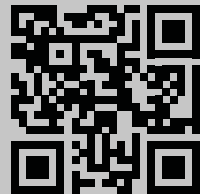

### ***Is documentation missing?***

See information in section

"2.2 Documentation and support", on page 12.

# Operation and maintenance

## EcoHeater

---

### Unit specification

#### Unit parts and accessories

Damper (code EMT-01)

Sound attenuator (code EMT-02)

Fire bypass section (code EHP-B)

#### Size

060	100	150
190	240	300

---

#### Filter

Coarse-65% (G4)

ePM10-60% (M5)

ePM2.5-50% (M6)

ePM1-50% (F7)

ePM1-60% (F7)

ePM1-70% (F8)

ePM1-85% (F9)

ePM1-70% (C7)

Aluminium

For filter class and size, see Technical data for the unit on IV Produkt's order portal.

# Operation and maintenance EcoHeater

---

## TABLE OF CONTENTS

<b>1</b>	<b>SAFETY</b> .....	<b>7</b>
1.1	Intended application .....	7
1.2	Unintended use .....	7
1.3	General safety .....	7
1.4	Structure of warning messages .....	8
1.5	General warning messages .....	8
1.6	Signs on the unit .....	10
1.6.1	Nameplate.....	10
1.7	Product liability .....	10
1.8	Operation and commissioning.....	11
1.9	Handling of refrigerant .....	11
1.10	Compressor protection .....	11
1.11	Safe shutdown of the unit .....	11
1.12	After the product's lifetime .....	11
<b>2</b>	<b>GENERAL INFORMATION</b> .....	<b>12</b>
2.1	Informational message, not safety-related .....	12
2.2	Documentation and support .....	12
2.3	Terms and abbreviations in the manual.....	12
2.4	Spare parts .....	12
2.5	Symbols on drawings and in manual .....	12
<b>3</b>	<b>DESCRIPTION OF THE EXHAUST AIR HEAT PUMP</b> .....	<b>13</b>
3.2	Orientation of the unit sides/parts .....	13
3.3	Unit parts .....	14
3.3.1	Fan section with filter .....	14
3.3.2	Compressor section and compressor protection .....	14
3.3.3	Fire bypass section with internal damper (option EHP-B) .....	14
3.3.4	Mixing valve .....	14
3.4	Function .....	14
3.4.1	Smoke and fire.....	15
3.4.2	Communication .....	16
3.4.3	Temperature control .....	16
3.4.4	Pressure control .....	16
3.4.5	Current limitation.....	16
3.5	Refrigerant detector system .....	17
<b>4</b>	<b>CONNECTION/CONTROL</b> .....	<b>18</b>
<b>5</b>	<b>COMMISSIONING AND OPERATION</b> .....	<b>19</b>
5.1	Before commissioning.....	19
5.1.1	For exhaust air heat pump with refrigerant R454B, .....	19
5.2	Starting and stopping the unit .....	20
5.3	Switch off the unit for service.....	20
5.4	Commissioning of fire bypass with damper (optional).....	20

# Operation and maintenance EcoHeater



---

5.5	Detector system status information.....	20
5.6	Operating parameters of the exhaust air heat pump .....	20
5.7	Detector system status information.....	21
<b>6</b>	<b>MAINTENANCE .....</b>	<b>22</b>
6.1	Maintenance intervals .....	22
6.2	Switch off the unit before maintenance.....	22
6.3	Starting the unit after maintenance .....	22
6.4	Maintain unit cabinets and surfaces .....	22
6.5	Water trap maintenance .....	23
6.6	Compressor section maintenance .....	23
6.6.1	Access to the frequency inverter .....	23
6.7	Filter maintenance .....	24
6.7.1	Replace disposable bag filter.....	24
6.7.2	Manually check pressure drop.....	25
6.8	Fan maintenance .....	26
6.8.1	Clean the fan and motor .....	26
6.8.2	Check/adjust overheating protection.....	26
6.8.3	Check airflows and duct pressure .....	27
6.8.4	Check the ring line for flow measurement .....	27
6.9	Maintenance DX coil (in cooling circuit) .....	28
6.9.1	Clean batteries.....	28
6.9.2	Check that the exhaust air heat pump regulates for heat.....	29
6.9.3	Aerate the liquid circuit .....	29
6.10	Maintenance of fire bypass section with damper (optional).....	30
6.10.1	Clean fire bypass section with damper.....	30
6.10.2	Check/adjust dampers.....	30
6.10.3	Check packing .....	30
6.11	Sound attenuator maintenance .....	30
<b>7</b>	<b>CHECKING AND REGISTERING THE REFRIGERANT CIRCUIT.....</b>	<b>31</b>
7.1	Leakage control and registration .....	31
7.2	Refrigerant detector system .....	31
<b>8</b>	<b>ALARM .....</b>	<b>32</b>
8.1	Alarm reset .....	32
8.2	Climatix alarm .....	32
8.3	Carel alarm .....	33
<b>9</b>	<b>TROUBLESHOOTING.....</b>	<b>34</b>
9.1	Climatix display - status message .....	34
<b>10</b>	<b>DISASSEMBLE AND DECOMMISSION .....</b>	<b>36</b>
10.1	Material content.....	36
10.2	Dispose and recycle .....	36
10.3	Disassemble the unit .....	37
<b>11</b>	<b>SERVICE SCHEDULE.....</b>	<b>38</b>

---

# Operation and maintenance EcoHeater

---

## 1 SAFETY

This section addresses important safety aspects during operation and maintenance, with the aim of increasing safety awareness and avoiding injury to people or damage to the environment and the unit.



- This manual contains important instructions. Read it carefully and follow the instructions.
- Pay special attention to warning and information messages, as well as markings on the product.
- Keep the manual for future use.

00177

### 1.1 Intended application

#### Intended use

EcoHeater The exhaust air heat pump is intended for use in apartment buildings, for energy recovery from exhaust air.

#### Intended user

The content of this manual is intended for personnel who connect, commission and maintain the exhaust air heat pump on site. Operator refers to the physical person (or legal person) who has technical responsibility for the equipment and systems covered by the F-Gas Regulation. The operator is usually the owner of the facility.

The operator is responsible for:

- minimising and preventing leakage
- taking action if a leak occurs
- ensuring that leak checks, service and repairs of the refrigerant circuit are carried out by a refrigeration-certified person
- ensuring that refrigerant handling is carried out in an environmentally safe manner and in accordance with applicable national regulations.

Certified refrigeration personnel are required for service and intervention on the unit's cooling circuit.

#### Intended use environment

- The unit is usually placed indoors, but is also available in an outdoor version.
- When installed indoors, the unit should be placed in a ventilated space with a maintained temperature of +7 – +30 °C and, during winter, a humidity level of < 3.5 g/kg dry air.

### 1.2 Unintended use

Any use other than that specified in the intended use is prohibited unless specifically permitted by IV Produkt. The unit is not permitted to be used or installed in an explosive environment.

### 1.3 General safety

Failure to follow the safety instructions may result in personal injury or damage to the air handling unit. To avoid injury to persons or damage to surroundings or equipment:

- Follow national and local laws/regulations for safe work, e.g. fall protection when working at height.
- Do not wear loose-fitting clothing or jewellery that could get caught.
- Do not step or climb on the unit.
- Use appropriate tools.
- Use appropriate personal protective equipment.
- Observe the unit's markings; product labels, information and warning stickers.



# Operation and maintenance EcoHeater

IV Produkt's order portal

## Personal protective equipment

Personal protective equipment should always be used based on the risks that occur in the workplace. For example, use safety shoes with steel toes, hearing protection, a hard hat, gloves, safety glasses, covering clothing, overalls, a face mask/protective mask and/or fall protection where the work and work environment require it.

## 1.4 Structure of warning messages

Warning messages in the instructions warn of risks when handling and assembling the product. Carefully follow the instructions in the warning messages.



The warning symbol indicates that a risk exists.

**WARNING!** indicates a potential hazard which, if not avoided, could result in death or **serious** injury.

**CAUTION!** indicates a potential hazard which, if not avoided, could result in **material damage** to the product or its surroundings, as well as impaired product function.

"**Risk for xxxxxx.**" indicates the risk in a short risk title.

*Descriptions in italics provide more detailed information about what the risk entails.*

- The points indicate how the user can avoid harm.

## 1.5 General warning messages



**WARNING!**  
**Risk of crushing, compression injury or cuts.**  
*There is no contact guard on moving parts, such as rotating fan impellers, rotary heat exchangers and opening/closing dampers.*

- The unit must not be powered until all ducts are connected.
- When the unit is in operation, inspection doors must be closed and locked.
- During service or other procedures, the unit must be switched off.
- Ensure power is off before placing hands in moving parts.
- Fan inspection door: Wait at least 3 minutes after shutting down the unit before opening the door.
- Damper inspection door: Wait at least 3 minutes after shutdown before opening the hatch.
- Make sure that hands do not get caught in dampers that have a spring return (which can be closed even when not powered).

00185-1



**WARNING!**  
**Risk of personal injury.**  
*During operation, an overpressure can be created inside the unit.*

- Allow the pressure to drop before you open the inspection doors.

00187



**WARNING!**  
**Risk of serious personal injury.**  
*Contact with refrigerants can cause frostbite to the skin.*

- Refrigerants and parts containing refrigerants may only be handled by persons with certificates in accordance with current EU regulations for refrigerants.
- Wear appropriate protective clothing.

00331





## WARNING!

### Risk of burns.

*The unit's internal parts, pipes and components may be hot during and after operation of the unit.*

- Inspection hatches must be closed and locked during operation of the unit.
- The unit must be switched off during service or repairs.
- Wait at least 5 minutes after switching off the unit before opening the compressor inspection hatch.

00408



## WARNING!

### Risk of cutting.

*Sharp edges can cause cuts.*

- Use appropriate personal protective equipment when the work requires it.

00181



## WARNING!

### Risk of life-threatening or serious personal injury.

*Electrical voltage can cause electric shock, burns and death. The product must not be energised during assembly.*

- Electrical connection and electrical work may only be carried out by a qualified electrician.
- For initial start-up of the unit, see Operation and Maintenance of the unit on IV Produkt's Order portal.

00176



## WARNING!

### Risk of life-threatening or serious personal injury.

*Added oxygen to the unit can spread the fire. The unit may be hot.*

- If a fire is suspected in the unit:
  - Do not open the door.
  - Call emergency services.
- Use caution when touching the unit surfaces/doors.

00356



## WARNING!

### Risk of fire in case of refrigerant leak.

*A2L refrigerants are mildly flammable and can ignite in the event of a leak.*

- In the event of suspected refrigerant leak or external damage to the refrigerant circuit has led to refrigerant leak:
  - Clear the ventilation room
  - Ensure good ventilation
  - Call for certified refrigeration technician.
- Service of cooling units/reversible heat pumps/exhaust air heat pumps may only be carried out by a certified refrigeration technician. In the event of repairs/service:
  - Shut down the unit at the service switch in the control equipment, then turn the safety switch to 0 position and lock. Note that there may be different safety switches for the different parts of the unit. All safety switches should be switched off and locked before repairs/service.
- Due to the risk of sparks, safety switches must not be used if there is a suspected refrigerant leak.
- Where detector system installed:
  - Make sure that the detector system is not disabled.
  - Make sure that external dampers in the ductwork do not block the unit's air flow, such as through uncontrolled closing.

00352



# Operation and maintenance EcoHeater

IV Produkt's order portal

## 1.6 Signs on the unit

Keep signs and decals clean from dirt. Replace missing, damaged or illegible signs and decals on the machine. Contact IV Produkt for replacement decals, specify the part number.

### 1.6.1 Nameplate

The exhaust air heat pump is equipped with a type plate located on the access side. The type plate is used to identify the product.

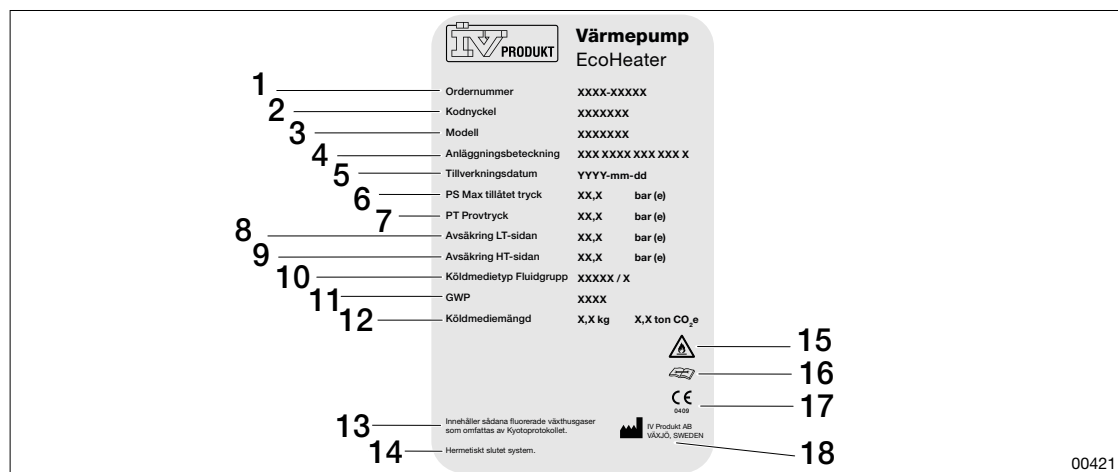

Figure: Example image: Unit type plate

- |                              |  |
|------------------------------|--|
| 1. Order number              | 10. Refrigerant type Fluid group   |
| 2. Code key                  | 11. GWP  |
| 3. Model                     | 12. Refrigerant quantity   |
| 4. Facility designation      | 13. Contains fluorinated greenhouse gases covered by the Kyoto Protocol. |
| 5. Date of manufacture       | 14. Hermetically sealed system.  |
| 6. PS Max allowable pressure | 15. Fire hazard  |
| 7. PT Test pressure          | 16. Read service manual  |
| 8. Fuse LP side              | 17. CE marking   |
| 9. Fuse HP side              | 18. Manufacturer   |

## 1.7 Product liability



### CE marking (EU)

The exhaust air heat pump is CE marked and meets the requirements of the specified directives and standards in the Declaration of Conformity. The marking covers the unit in the version in which it was delivered and provided that it has been assembled and put into operation according to IV Produkt's instructions. This does not cover units that have been modified, components that have been added later, refrigerant types that have been replaced, or the rest of the system in which the unit may be part. The unit may not be put into use until the system in which it is part complies with the requirements for CE marking.

The Declaration of Conformity is available on the Order Portal, "[Documentation for your unit](#)", on page 2.

### Manufacturer

The exhaust air heat pump is manufactured by IV Produkt AB, Sjöuddevägen 7, S-350 43 VÄXJÖ.

### Guarantee

For proper function and for the warranty to apply, the instructions must be followed. Correct

commissioning is a prerequisite for the product warranty to apply. If any intervention is made to the exhaust air heat pump during the warranty period without approval from IV Produkt, the warranty will be void.

### **Extended warranty**

Extended warranty is additional to the order and in order to claim the extended warranty (5 years) a complete documented and signed IV Produkt Service and Warranty Book must be presented, according to ABM 07 with supplement ABM-V07 or according to NL 17 with supplement VU 20.

### **Disclaimer**

Ongoing product development may result in changes without prior notice.

## **1.8 Operation and commissioning**

Commissioning of the unit must be carried out by competent personnel according to the Commissioning Protocol which can be downloaded from IV Produkt's order portal. See ["Documentation for your unit", on page 2.](#)

Units have been designed, calculated and manufactured according to given operating conditions which must correspond to the unit's use, for optimal function and good operating economy. External circumstances must not be changed without checking that the changes are within the intended operating range of the unit.

## **1.9 Handling of refrigerant**

The exhaust air heat pump contains a cooling circuit that is subject to requirements under the European F-gas regulation. For further information, please refer to national requirements for refrigerant handling.

### **Leakage control and registration**

Leakage control and registration must be carried out in accordance with national, applicable regulations. For further information, see ["7 Checking and registering the refrigerant circuit", on page 31.](#)

There is an alarm for refrigerant leakage.

## **1.10 Compressor protection**

The exhaust air heat pump is interlocked above the unit. For more information, see ["3.5 Refrigerant detector system", on page 17.](#)

## **1.11 Safe shutdown of the unit**

Before switching off the unit, it must be checked that there is no leak alarm. In the event of a refrigerant leak alarm, contact certified refrigeration technician.

A lockable safety switch is installed in the unit from the factory. During service, the unit must be turned off with a lockable safety switch.

When working on a powered unit, the unit must always be turned off and the safety switch set to position 0. For correct shutdown see ["5.3 Switch off the unit for service.", on page 20.](#)

## **1.12 After the product's lifetime**

For disassembly and decommissioning of air handling units, see ["10 DISASSEMBLE AND DECOMMISSION", on page 36.](#)



# Operation and maintenance EcoHeater

IV Produkt's order portal

## 2 GENERAL INFORMATION

### 2.1 Informational message, not safety-related

	Symbol together with information text highlights difficulties and also gives tips and recommendations.	00182
--	--	-------

### 2.2 Documentation and support

The documentation for your unit is available at IV Produkt's order portal. See "[Documentation for your unit](#)", on page 2.

It may take up to two weeks before all documentation is available on IV Produkt's order portal. The text "Documentation in progress" is displayed until the documentation is complete. If documentation is missing or incorrect, please contact DU/Documentation. For other support, contact the department to which the case applies. See contact information on the back of the manual.

### 2.3 Terms and abbreviations in the manual

Term	Explanation
Unit part	Part of the unit. May contain function (for example fan, media etc) but may also be an empty part.

### 2.4 Spare parts

Spare parts list is available at IV Produkt's order portal. Order spare parts and accessories from IV Produkt. See contact information on the back of the manual. Please state the order number and unit designation from the type plate, located on the unit.

### 2.5 Symbols on drawings and in manual

	Extract air		Exhaust air
	Fan		Filter
	Shut-off damper		Sound attenuator
	DX battery		Quick contact
	Compressor		

### 3 DESCRIPTION OF THE EXHAUST AIR HEAT PUMP

#### 3.1 Unit design

EcoHeater The exhaust air heat pump consists of a fan/filter section and a compressor section. The exhaust air heat pump can also be equipped with a fire bypass section with internal damper (optional EHP-B).

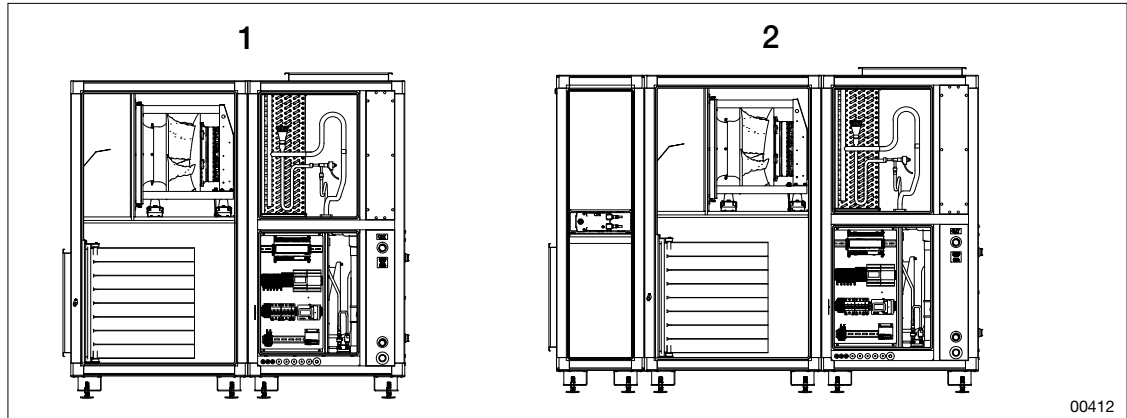

Figure: Examples of configurations of EcoHeater.

1. EcoHeater with fan and compressor section
2. EcoHeater with fan and compressor section and fire bypass section.

#### 3.2 Orientation of the unit sides/parts

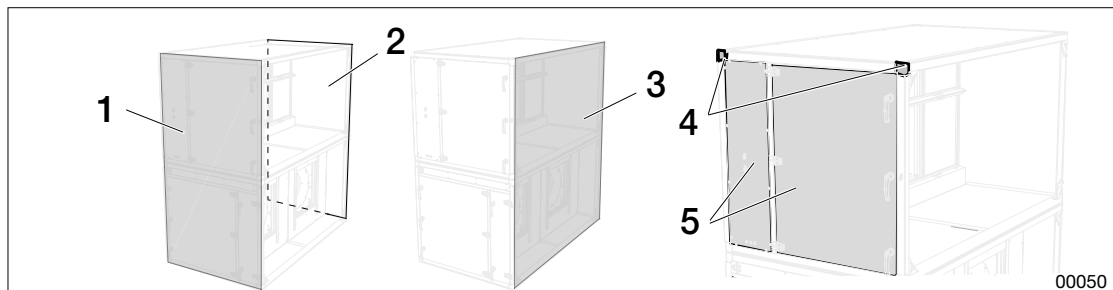

Figure: Parts of the unit

1. Access side
2. Back
3. Gable side
4. Cover detail at joint
5. Covers



# Operation and maintenance

## EcoHeater

### 3.3 Unit parts

#### 3.3.1 Fan section with filter

The fan section has a direct-driven chamber fan with an EC motor and a deep-pleated filter. EcoHeater sizes 240 and 300 have double fans. The fan unit is extendable. Filter replacement is carried out from the front of the unit.

#### 3.3.2 Compressor section and compressor protection

The compressor section consists of a DX recovery coil, electronic expansion valve, step-free speed-controlled compressor, fully brazed plate heat exchanger (between refrigerant and liquid side), freeze-protected condensate drain (for outdoor versions) and integrated control equipment with electrical connections.

The cooling circuit is integrated into the compressor section. Compressor and control components are shielded from the exhaust air stream. The cooling circuit is factory tested and built according to PED 2014/68/EU, Module B + Module C2. Construction is carried out according to EN378.

The cooling circuit (R410A or R454B) is equipped with a high-pressure switch and protection and alarm functions for high/low pressure. The cooling circuit is controlled so that freezing in the exhaust air coil cannot occur.

In the event of an alarm from FI (frequency inverter) or HP1 (high pressure switch), the compressor is stopped. The high-pressure switch is reset manually.

For outdoor use, freeze protection (1 m heating cable) for condensate drain is included.

#### 3.3.3 Fire bypass section with internal damper (option EHP-B)

The fire bypass section redirects the airflow in the event of a fire by drawing the smoke out into a bypass duct.

#### 3.3.4 Mixing valve

When a mixing valve is connected to an external control system that controls the heating of the radiators and the charging of the tanks, the mixing valve's minimum operating time shall be 90 seconds.

### 3.4 Function

To ensure the operational reliability of the EcoHeater, the incoming water to the EcoHeater must be at least 20 °C. Recovered energy is returned to the property's heating system.

EcoHeater has a time program that is preset from the factory for continuous operation for the selected type of fan control. The time program can be changed in the Climatix display for fan control in up to three different operating modes.

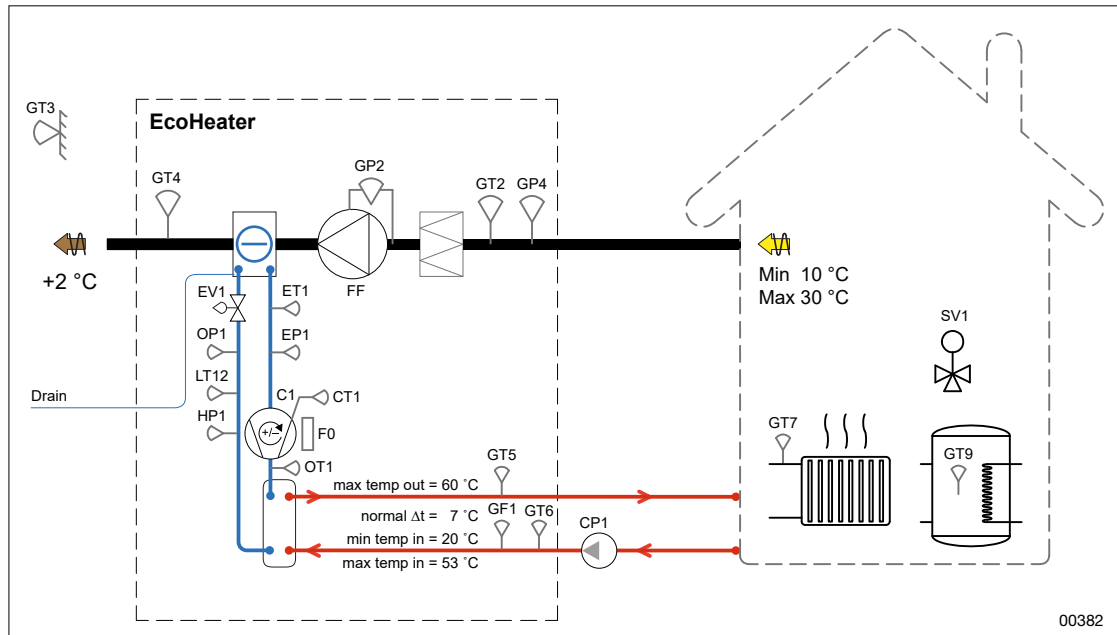

Figure: Schematic diagram, example

C1	Compressor, variable speed-controlled	GT2	Exhaust air temperature sensor
F0	Frequency converter for compressor	GT3	Temperature sensor outside air (location north-east)
EF	Exhaust fan, speed-controlled	GT4	Extract air temperature sensor
GP4	Exhaust duct pressure	GT5	Water outlet temperature sensor
HP1	High pressure switch	GT6	Water inlet temperature sensor
CP1	Circulation pump heat pump	GT7	Temperature sensor supply line radiator circuit, internal control (not external control 0 – 10 VDC).
OP1	High pressure sensor cooling circuit	GT9	Tank charging temperature sensor
EP1	Low pressure sensor cooling circuit	OT1	Hot gas temperature sensor
GF1	Water flow sensor	ET1	Temperature sensor cooling circuit suction gas
EV1	Expansion valve, electronic	CT1	Compressor sump temperature sensor
Drain	Condensate drain, frost-proof (outdoor version)	LT12	Temperature sensor liquid line

- In the event of an operating error on the EF (exhaust fan), an alarm is triggered and the unit stops.
- If GT6 (water inlet temp sensor) registers a temperature that is too high, the compressor is stopped. Restart occurs automatically when the temperature drops to the permitted value.
- If EP1 (pressure sensor cooling circuit) and/or GT4 (exhaust air temp sensor) register a temperature that is too low, the compressor speed is reduced until the temperature reaches the permitted value.
- If OP1 (high pressure sensor cooling circuit) registers a too high condensing temperature, the compressor speed is reduced.
- If GT4 (exhaust air temp sensor) is lower than 12 °C, compressor start is blocked.
- If GT4 (exhaust air temp sensor) is more than 3 °C lower than GT2 (exhaust air temp sensor), compressor start is blocked.
- If GF1 (water flow sensor) registers too low a flow, compressor start is blocked. Restart occurs automatically when the permitted flow is reached.

### 3.4.1 Smoke and fire

Fire alarm is reset:

- GT2 (exhaust air temperature sensor) or optional GT72 (fire thermostat) registers a higher temperature than the set alarm limit
- or if GX2 (smoke detector) indicates smoke



# Operation and maintenance EcoHeater

IV Produkt's order portal

---

## 3.4.2 Communication

Communication via Modbus TCP/IP and text-web is included as standard.

## 3.4.3 Temperature control

Temperature control for EcoHeater can be controlled via an external control signal (0-10 VDC from a substation, for example a district heating centre), an internal radiator curve or based on the accumulation tank temperature, so that full capacity from the unit is utilised before the property's alternative energy sources are used.

## 3.4.4 Pressure control

Pressure control can be used by GP4 (exhaust air duct pressure) keeping the pressure in the exhaust air duct constant. The current airflow can be read in the Climatix display.

If the duct pressure deviates from the setpoint after a set time, an alarm is generated.

## 3.4.5 Current limitation

EcoHeater is equipped with a function that measures the compressor's power consumption. The compressor current is limited by the set value of the main fuse. Reduction is allowed by up to 50% of maximum compressor speed. If the unit is connected to a fuse that is smaller than the recommended one, this function should be used. For recommended fuse protection, see Technical data on IV Produkt's order portal.

To activate the function in Climatix:

1. Log in (6006).
2. Go to System Settings > Configuration > Basic Data - Compressor Current Limitation and select YES.
3. Restart Climatix.
4. Go to System Settings > Configuration > Basic Data - Compressor Current Limit and set the maximum power consumption of the compressor.



### 3.5 Refrigerant detector system



**WARNING!**

**Risk of serious personal injury.**

*Contact with refrigerants can cause frostbite to the skin.*

- Refrigerants and parts containing refrigerants may only be handled by persons with certificates in accordance with current EU regulations for refrigerants.
- Wear appropriate protective clothing.

00331



- For leak detection and evacuation to function effectively, the unit must be powered up and the service switch must be in the "Auto" position at all times after installation, except during intervention/service.
- In the event of an alarm, the fault must be rectified and the alarm reset.
- The air handling unit runs until the fault is rectified.

The detectors are self-calibrating and require no adjustment or maintenance. For a description of the Detector System's function, see "[3.5 Refrigerant detector system](#)", on page 17.

The exhaust air heat pump with refrigerant R454B is equipped with a detector that detects refrigerant leaks. For units with refrigerant R410A, the detector equipment is available as an option.

An alarm is triggered and the unit's fans start to evacuate the refrigerant:

- in case of refrigerant leakage.
- if the detector is out of order.



## Operation and maintenance EcoHeater

IV Produkt's order portal

---

### 4 CONNECTION/CONTROL

	<p><b>WARNING!</b> <b>Risk of life-threatening or serious personal injury.</b> <i>Electrical voltage can cause electric shock, burns and death. The product must not be energised during assembly.</i></p> <ul style="list-style-type: none"><li>• Electrical connection and electrical work may only be carried out by a qualified electrician.</li><li>• For initial start-up of the unit, see Operation and Maintenance of the unit on IV Produkt's Order portal.</li></ul>
--	--

00176

For information on electrical connection, see the Installation Instructions and the current control diagram on IV Produkt's order portal. See "[Documentation for your unit](#)", on [page 2](#).

## 5 COMMISSIONING AND OPERATION



### WARNING!

#### Risk of life-threatening or serious personal injury.

*Electrical voltage can cause electric shock, burns and death. The product must not be energised during assembly.*

- Electrical connection and electrical work may only be carried out by a qualified electrician.
- For initial start-up of the unit, see Operation and Maintenance of the unit on IV Produkt's Order portal.

00176



### CAUTION!

#### Risk of damage to compressor.

*Circulation of cold oil in the speed-controlled compressor may damage the compressor.*

- The reversible heat pump must be powered up for at least 8 hours before it is first started.
- Make sure that no alarm is triggered about 30 seconds after the unit is energised. If an alarm is triggered, follow instructions for the alarm.

00188

Commissioning of the unit must be carried out by competent personnel according to documentation from IV Produkt. See "[Documentation for your unit](#)", on page 2.

Documents for commissioning:

- Commissioning protocol (for units delivered with MX control equipment)
- Control diagram
- Connection instructions (separate manual for general connection and fuse protection)

### 5.1 Before commissioning

Make sure that:

- Electricity is connected via a lockable safety switch.
- all ducts are connected.
- the unit is clean and there are no loose parts inside the unit.
- The unit must have been powered on for at least eight hours before it is started.

#### 5.1.1 For exhaust air heat pump with refrigerant R454B,

Ensure that external dampers communicate with the unit's control equipment so that the airflow through the unit cannot be blocked uncontrollably.

1. See "[1 SAFETY](#)", on page 7.
2. Connect power via lockable safety switch.
3. Clean all particles and loose parts from the unit.
4. Connect all ducts.
5. Power up the unit.
6. Wait at least eight hours before starting the unit.



# Operation and maintenance EcoHeater

IV Produkt's order portal

## 5.2 Starting and stopping the unit



The safety switch is not designed for starting and/or stopping the unit.  
The unit must not be switched off if a refrigerant leak is suspected.

During operation: Start and stop the unit via the service switch in the control equipment.

During maintenance and service, also turn off the unit via the safety switch. See "[6.2 Switch off the unit before maintenance.](#)", on page 22.

## 5.3 Switch off the unit for service.

1. Switch off via the service switch in the control equipment.
2. Turn the safety switch to position 0.
3. Lock the safety switch.

## 5.4 Commissioning of fire bypass with damper (optional)

1. Make sure that the fire gas bypass is connected to the unit's fan section and connected according to the Control Diagram on IV Produkt's order portal.
2. Make sure that the Climatix display (Unit > Damper > Fire damper) shows "On" and "Yes".
3. Make sure that the end position function is correct. On the Climatix display, go to Unit > Damper > Fire damper - Start manual test and select "Active".

If an error message appears, correct the error and try again.

## 5.5 Detector system status information

The status information can be read in the Climatix display.

## 5.6 Operating parameters of the exhaust air heat pump

Parameter	Value	Explanation
Heating circuit	x%	Heating requirement
Circulating pump	From/To	Circulation pump operating mode
Heat pump operating mode		Operating mode for exhaust air heat pump
Heat pump status		Carel heat pump operation status
Current heat demand HP	x%	heat demand for heat pump
Alarm	>	Alarms are displayed in the event of a fault in the inverter or compressor. In case of alarm, see " <a href="#">3.5 Refrigerant detector system</a> ", on page 17.
Settings	>	
Compressor C1	To/From	Compressor operating mode
Frequency inverter output signal	x%	Frequency inverter output signal
Expansion valve 1	x%	Expansion valve position
COP		Calculated COP

Parameter	Value	Explanation
Low pressure C1	x.x bar	Relative pressure from low pressure sensor
High pressure C1	x.x bar	Relative pressure from high pressure sensor
Overheating C1	x.x K	Measured overheating
Suction gas temp C1	x.x °C	Measured suction gas temp.
Evaporation temperature C1	x.x °C	Calculated evaporation temperature based on low pressure
Condensation temp C1	x.x °C	Calculated condensation temperature based on high pressure sensor
Hot gas temperature	x.x °C	Temperature out of compressor
Liquid line temperature	x.x °C	Temperature after the condenser
Sub-cooling	x.x °C	Measured sub-cooling
Electric compressor power	x.x kW	Estimated electrical power drawn by the compressor
Cooling effect	x.x kW	Estimated cooling effect
Heat output	x.x kW	Calculated heat output
Exhaust air temperature	x.x °C	Exhaust air temperature
Heat pump inlet temp	x.x °C	EcoHeater outlet water temperature
Heat pump return temp	x.x °C	Incoming water temperature to EcoHeater
Refrigerant detector		Link to refrigerant detector menus

## 5.7 Detector system status information

Information	Value/ example	Explanation
<b>Compressor compartment</b>		
Refrigerant leakage	Normal	Information about leak alarms
Alarm detector	Normal	Information about alarms on the detector
Concentration LFL	0.0%	Measured current refrigerant concentration
Chip temperature	22.2 °C	Internal detector temperature
Temperature heater	25.0 °C	Internal detector heater temperature
Firmware Version	1.0	Software version in the detector
Sensor ID	54291003	The detector's identification number
Calibrate detector		Function to calibrate or test the detector
Compressor compartment calibration status	OK	Calibration information



# Operation and maintenance EcoHeater

IV Produkt's order portal

## 6 MAINTENANCE

### 6.1 Maintenance intervals

Checks and measures should be carried out at least every twelve months and/or as necessary. See recommended maintenance in the section for each unit part. A service list to facilitate maintenance is provided at the end of the manual.

### 6.2 Switch off the unit before maintenance.



The safety switch is not designed for starting and/or stopping the unit. The unit must not be switched off if a refrigerant leak is suspected.

The unit should always be switched off before starting any inspection or maintenance. A torch or headlamp can be used for inspection and maintenance.

1. Read section "1 SAFETY", on page 7 carefully and pay particular attention to the warnings in sections "1.5 General warning messages", on page 8 and "1.11 Safe shut-down of the unit", on page 11.
2. Switch off the unit via the service switch in the control equipment. See "6.2 Switch off the unit before maintenance.", on page 22.
3. Lock all safety switches in the 0 position. Please note that different parts may have separate safety switches.
4. Before opening doors, wait until all fans have stopped.

### 6.3 Starting the unit after maintenance

1. Clear any alarms. See "8.1 Alarm reset", on page 32.
2. Make sure that there are no loose items, such as tools, in the unit.

### 6.4 Maintain unit cabinets and surfaces



#### CAUTION!

##### Risk of damage to the product.

*Corrosive substances and strong cleaning agents can damage the surface layer.*

- Never use strong cleaning agents or corrosive substances when cleaning the unit.

00183



#### CAUTION!

##### Risk of damage to the product.

*Swarf from drilling left behind after assembly can lead to corrosion and rust on the surface layer of the unit.*

- Make sure that the surfaces of the unit are clean of swarf.

00195

1. Switch off the unit. See "6.2 Switch off the unit before maintenance.", on page 22.
2. Vacuum the inside.
3. Wipe the interior surfaces with a damp cloth. Use warm water and mild (non-corrosive) detergent.
4. In case of heavy soiling, use an environmentally friendly degreaser. Follow the manufacturer's instructions.

## 6.5 Water trap maintenance



### CAUTION!

#### Risk of environmental impact.

*Depending on the business at which the unit is in operation, the extract air may contain environmentally harmful substances that can condense into drains from the unit.*

- Ensure compliance with applicable national and international environmental regulations.

00380

Every 12 months and as needed

Make sure the water trap is working and not clogged.

Waste products and deposits in the water trap can cause flooding in the unit.

1. Open the water trap.
2. Remove the ball and clean.
3. Flush the water trap with hot water, if necessary with added detergent. Make sure that no deposits remain.

## 6.6 Compressor section maintenance



### WARNING!

#### Risk of burns.

*The unit's internal parts, pipes and components may be hot during and after operation of the unit.*

- Inspection hatches must be closed and locked during operation of the unit.
- The unit must be switched off during service or repairs.
- Wait at least 5 minutes after switching off the unit before opening the compressor inspection hatch.

00408



Operating parameters for the exhaust air heat pump must not be changed without ensuring that the changes are within the unit's operating range.

For maintenance, see the respective part in the compressor section.

### 6.6.1 Access to the frequency inverter

Before taking action, turn off the unit. See "[6.2 Switch off the unit before maintenance.](#)", on [page 22](#).

#### Access via inspection hatch

1. Remove filter from filter cabinet.
2. Open the inspection hatch.

#### Access via the service cover

1. Remove the service cover.

After measures, reassemble parts and close doors.



# Operation and maintenance EcoHeater

IV Produkt's order portal

## 6.7 Filter maintenance

	<b>WARNING!</b> <b>Risk of inhalation of harmful particles.</b>
	<p>When changing filters, particles, such as dust, may come loose from the used filter.</p> <ul style="list-style-type: none"><li>• Wear a protective mask when changing filters.</li><li>• Use caution when handling used filters.</li><li>• Thoroughly clean the filter cabinet after replacement as particulate matter may become loose and remain in the cabinet.</li></ul>

00325

### At least every 12 months

Ensure (visually) that the unit parts are clean inside and out. See "[6.4 Maintain unit cabinets and surfaces](#)", on page 22.

Replace the filter if it is dirty or clogged. Check the sealing gasket for damage and tightness along the entire contact surface of the filters. Replace if necessary. Filter replacement intervals vary depending on operating conditions and the amount of particles and odour-causing substances in the air. Manual checks only needs to be carried out if the unit is not equipped with FLC.

Replace the filter if the specified pressure drop is reached or if a filter alarm is triggered. "[6.7.2 Manually check pressure drop](#)", on page 25

### 6.7.1 Replace disposable bag filter

1. Switch off the unit. See "[6.2 Switch off the unit before maintenance.](#)", on page 22.
2. If there is a permanently mounted filter guard, detach the necessary measuring hoses to the hatch/post to be able to open the inspection hatch.
3. Pull the red handles until the filter comes loose from the rails and stops.

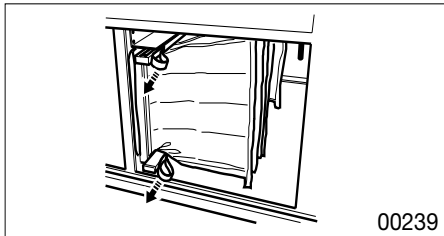

4. Release the handles and hold the filter frame.
5. Carefully pull the filter outwards and lift it out.
6. Place the used filter in a bag/rubbish bag and seal. Some filter kits include bags for filter replacement.
7. Install a new filter. Make sure it is pushed in as far as it will go into the filter cabinet.
8. Press the upper and lower filter locks (at the red handles) until a clicking sound is heard.
9. Close the inspection hatch.
10. Dispose of the used filter according to applicable environmental regulations. See "[10](#)



*DISASSEMBLE AND DECOMMISSION", on page 36.*

## 6.7.2 Manually check pressure drop

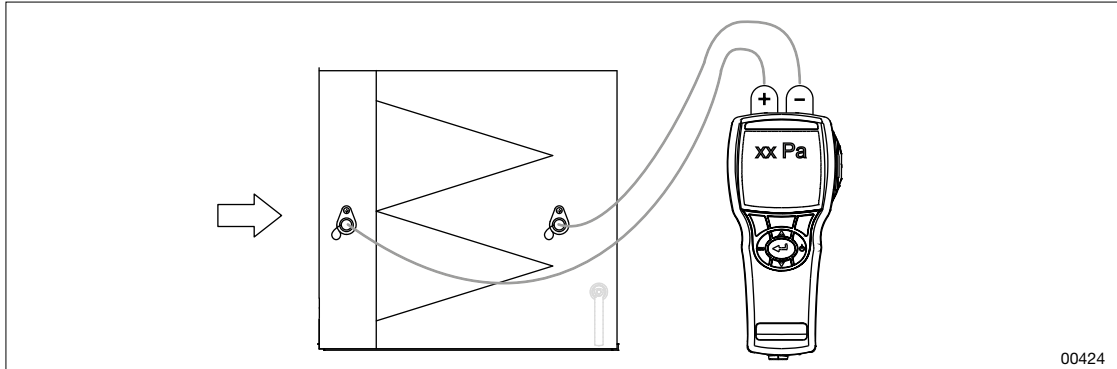

*Figure: Check pressure drop across filter*

1. Connect the manometer to the measuring outlets on each side of the exhaust air filter.
2. Measure the filter pressure drop.
3. Compare the value with the initial pressure drop measured when the unit was put into operation (on the filter part label).



# Operation and maintenance EcoHeater

IV Produkt's order portal

## 6.8 Fan maintenance

Every 12 months and as needed
Ensure (visually) that the unit parts are clean inside and out. See " <a href="#">6.4 Maintain unit cabinets and surfaces</a> ", on page 22.
Ensure (visually) that the fan parts are clean and dust-free.
Ensure: - that the fan does not make any unusual noises (for example, scraping, thumping or rattling noises). - that the fan does not vibrate or is unbalanced. Well-functioning bearings emit a faint humming sound. If the fan appears to be damaged, contact a service technician.
Ensure (visually) that the impeller overlaps the inlet cones.
Ensure (visually) that the fan rotates in the direction indicated by the markings on the fan. If the fan has the wrong rotation direction, contact a service technician.
Ensure (visually) that the fixing screws, suspension devices, stand, vibration dampers and gaskets (around the connection hole) are secure and undamaged. Tighten or replace if necessary.
Check the ring line for flow measurement.
Ensure that airflows match settings.

### 6.8.1 Clean the fan and motor

1. Switch off the unit. See "[6.2 Switch off the unit before maintenance.](#)", on page 22.
2. When the fans have stopped, open the inspection hatch.
3. Remove fans. See **the Assembly Instructions** for the unit. Note how the hoses are positioned before removing.
4. Vacuum the fan and motor carefully with a soft vacuum cleaner nozzle.
5. Wipe the fan wheel and surfaces with a damp cloth. Use warm water and mild (non-corrosive) detergent.
6. For heavier soiling, use an environmentally friendly degreaser.
7. Clean the inside of the unit cabinet. See "[6.4 Maintain unit cabinets and surfaces](#)", on page 22.
8. Put the fan back in place. See **the Assembly Instructions** for the unit.
9. Ensure that all hoses and connectors are returned to their original locations.

### 6.8.2 Check/adjust overheating protection

Risk of internal overheating if thick layers of dirt prevent cooling of the motor stator frame.

#### Reset overheat protection (applies to ELFF-EC01, -EC02, -ECA2)

1. Disconnect power to the fan motor.
2. Wait at least 20 seconds after the impeller stops rotating.
3. Restore power to the fan motor.

## 6.8.3 Check airflows and duct pressure

Too high a pressure drop in the duct system can lead to too low an air flow, which can cause a poor room climate, for example, humid air can be pushed out into the building.

Read the flow shown on the handheld terminal display and adjust if necessary.

### Adjust the air flow in the compressor compartment

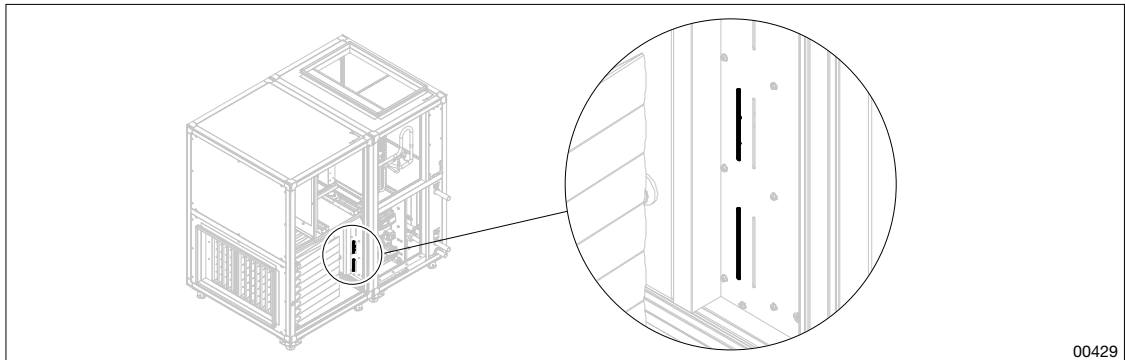

Figure: Slots

The pre-punched slots in the sheet metal are covered with stickers in manufacture that are removed at low duct pressures.

At duct pressure:

- < 150 Pa - remove a sticker
- < 120 Pa - remove two decals

## 6.8.4 Check the ring line for flow measurement

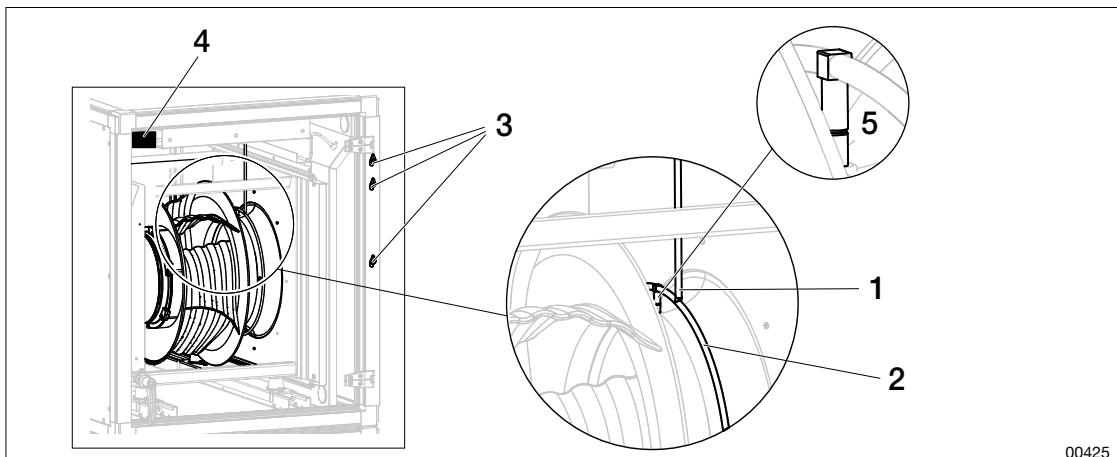

Figure: Check ring line

1. Measuring hose
2. Ring line
3. Measurement outlet
4. Pressure sensor
5. Measuring nipple



# Operation and maintenance EcoHeater

IV Produkt's order portal

Check the hose routing and ensure:

- that the ring line is attached to the respective measuring nipple on the fan cone
- that the ring line is undamaged and not leaking.
- that the measuring hose is attached to the ring line.
- that the entire hose between the ring line and the pressure sensor/measurement outlet is undamaged and not pinched or leaking.

## 6.9 Maintenance DX coil (in cooling circuit)

### **WARNING!**

#### **Risk of burns.**

*The parts, pipes and components of the unit may be hot during and after operation of the unit.*



- When the unit is in operation, inspection hatches must be closed and locked.
- During service or other interventions, the unit must be switched off.
- Inspection hatch for cooling unit/reversible heat pump: Wait at least 30 minutes after shutting down the unit before opening the compressor door.
- Inspection hatch for heating coil: Wait at least 5 minutes after shutting down the unit before opening the compressor door.

00184

#### **Every 12 months and as needed**

Ensure that the fins are clean and undamaged. If they are damaged, contact a service technician.

Make sure the battery is not leaking. In case of leakage, contact a service technician.

Ensure (visually) that the drip tray and bottom plate are clean. Clean if necessary.

Ensure that the water trap (without non-return valve) is filled with water. See "[6.5 Water trap maintenance](#)", on page 23.

Ensure that the system pressure is the same as at installation. If necessary, top up the system with fluid. See "[6.9.3 Aerate the liquid circuit](#)", on page 29.

Ensure that the liquid circuit is aerated. See "[6.9.3 Aerate the liquid circuit](#)", on page 29.

### 6.9.1 Clean batteries

1. Switch off the unit. See "[1.11 Safe shutdown of the unit](#)", on page 11.
2. When the fans have stopped, open the inspection hatch.
3. From the inlet side: Vacuum gently with a soft vacuum cleaner nozzle.
4. From the outlet side: Blow clean carefully with compressed air.
5. For heavier soiling, spray with warm water with added dishwashing detergent, which does not corrode aluminium.
6. Clean the inside of the unit cabinet. See "[6.4 Maintain unit cabinets and surfaces](#)", on page 22.

## 6.9.2 Check that the exhaust air heat pump regulates for heat

Temporarily increase the heat demand signal and check that there is an increase in compressor speed and liquid temperature on the outgoing pipe side (from the exhaust air heat pump).

- When controlling heat from an external substation, the heat demand signal is changed in the substation.
- When controlling heat via internal control in the exhaust air heat pump, the heat demand signal is changed by adjusting the control curve upwards, which is accessed under *Temperature settings* in the handheld unit.

## 6.9.3 Aerate the liquid circuit

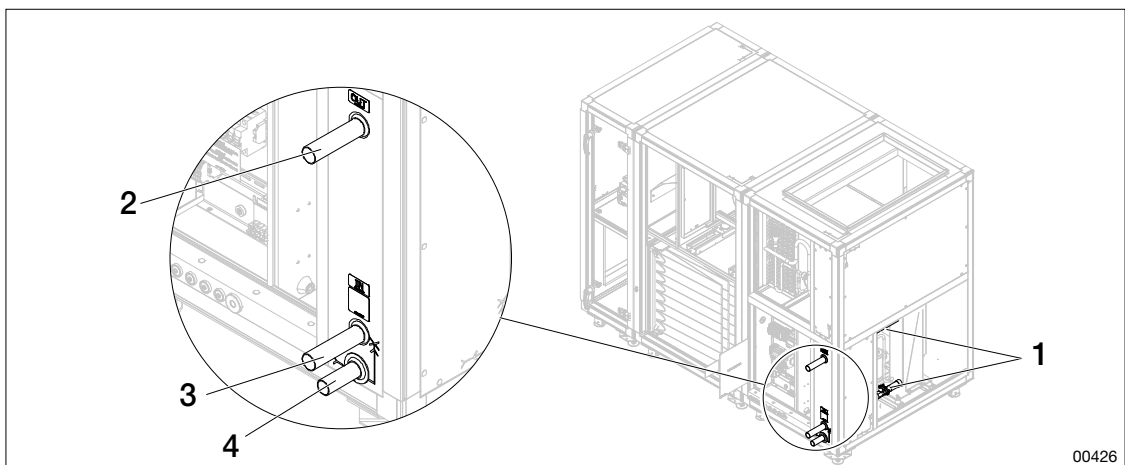

Figure: Venting and draining

- |                   |             |
|-------------------|-------------|
| 1. Liquid circuit | 3. Inlet    |
| 2. Outlet         | 4. Drainage |

1. Switch off the unit. See "[1.11 Safe shutdown of the unit](#)", on page 11.
2. Aerate the fluid circuit by opening the bleeder screw/nipple mounted on the outlet. Venting accessories are not included in IV Produkt's delivery. See also Assembly instructions for the unit.



# Operation and maintenance EcoHeater

IV Produkt's order portal

## 6.10 Maintenance of fire bypass section with damper (optional)



### **WARNING!**

#### **Risk of fire**

*Defective function of shut-off dampers can lead to an increased fire risk.*

- Ensure that the shut-off damper is not clogged and is functioning properly.

00430

#### **Every 12 months and as needed**

Ensure (visually) that the damper is clean and undamaged. See "[8 ALARM](#)", on page 32.

Ensure (visually) that the damper opens and closes properly. In the event of a fault, contact a service technician.

Ensure (visually) that the damper seals when closed. Adjust the actuator (not for trim dampers). Make sure that no screws are installed through the drive mechanism/damper blades.

Ensure that gaskets are undamaged and leak-proof. Replace damaged gaskets. See "[Personal protective equipment](#)", on page 8.

### 6.10.1 Clean fire bypass section with damper

1. Switch off the unit. See "[6.2 Switch off the unit before maintenance.](#)", on page 22.
2. When the fans have stopped, open the inspection hatch.
3. Vacuum gently with a soft vacuum cleaner nozzle.
4. Wipe with a damp cloth. Use warm water and mild (non-corrosive) detergent.
5. For heavier soiling, use an environmentally friendly degreaser. Follow the instructions on the packaging.

### 6.10.2 Check/adjust dampers

#### **Adjust the damper motor**

Ensure that the damper closes and opens fully. If not, adjust the damper motor on the damper shaft.

### 6.10.3 Check packing

1. Feel the gasket with your hands and make sure it has no nicks or damage.
2. Check and ensure that the gasket is tight and has no gaps.

## 6.11 Sound attenuator maintenance

#### **Every 12 months and as needed**

Ensure (visually) that the surfaces of the baffle elements are clean and undamaged. See "[6.4 Maintain unit cabinets and surfaces](#)", on page 22.

## 7 Checking and registering the refrigerant circuit



- Leakage checks must be carried out by a certified refrigeration certified technician.
- The use and control of pressurised devices must comply with applicable national legislation and meet the requirements set out in the European F-Gas Regulation. The cooling circuit should be checked for leaks and other effects, such as wear and tear.

### 7.1 Leakage control and registration

The following must be registered when keeping records.

- filled amount of refrigerant
- type of refrigerant
- refrigerant disposed of
- outcomes of checks/repairs:
  - leak sealing
  - component replacement
- person and company that performed service and maintenance
- date and time of inspection

### 7.2 Refrigerant detector system

A detector system is installed on units with refrigerant R454B. For units with refrigerant R410A, the detector system is available as an option. For more information about the function, see "[3.5 Refrigerant detector system](#)", on [page 17](#). To identify whether the unit has a detector system installed, refer to the order-specific documentation for your unit.



# Operation and maintenance EcoHeater

IV Produkt's order portal

## 8 ALARM



Operating parameters for the exhaust air heat pump must not be changed so that they are outside the unit's operating range. If errors occur, an alarm is triggered and:

- the compressor is stopped.
- a red light flashes on the Climatix display and on the Carel unit.

Call authorised refrigeration service if the same alarm repeats after action has been taken.

### 8.1 Alarm reset

1. Check what the alarm means.
2. Take action as described.
3. Hold down the Carel display button (*Alarm reset*) for about three seconds.

### 8.2 Climatix alarm



Leak checks and replacement of parts in the refrigerant circuit must be carried out by a certified refrigeration technician. See "[1.9 Handling of refrigerant](#)", on page 11 and "[7 Checking and registering the refrigerant circuit](#)", on page 31.

Alarm code	Possible cause	Measure
Compr. Sa.alarm	Sum alarm.	See alarms in Carel table
C1 H. pressure switch	<ol style="list-style-type: none"> <li>1. High pressure switch triggered.</li> <li>2. Alarm on frequency converter.</li> </ol>	<ol style="list-style-type: none"> <li>1. Reset the high pressure switch by pressing the red button.</li> <li>2. Reset the frequency converter by turning off the 3-phase supply (wait 60 seconds) and turning on the 3-phase supply.</li> </ol>
C1 EEV engine fault	Fault in the electrical connection to the expansion valve.	Ensure that there is a correct electrical connection to the expansion valve.
C1 low pressure sensor	Open circuit or short circuit to low pressure sensor.	Make sure that: <ul style="list-style-type: none"> <li>• EVD and sensors work</li> <li>• there are no broken cables.</li> </ul>
C1 suction gas sensor	Open circuit or short circuit to suction gas sensor.	Ensure: <ul style="list-style-type: none"> <li>• EVD and sensors work</li> <li>• there are no broken cables.</li> </ul>
C1 high pressure sensor	Open circuit or short circuit to high pressure sensor.	Ensure: <ul style="list-style-type: none"> <li>• EVD and sensors work</li> <li>• there are no broken cables.</li> </ul>
C1 low overheating	Compressor stop caused by low overheating.	<ul style="list-style-type: none"> <li>• Reset the alarm so that the compressor can start again.</li> <li>• During compressor operation, ensure that the expansion valve regulates the overheating to its setpoint.</li> </ul>



Alarm code	Possible cause	Measure
C1 LOP	Compressor stop caused by low evaporation temperature.	<ul style="list-style-type: none"> <li>Reset the alarm.</li> <li>In the event of recurring errors, contact authorised service personnel.</li> </ul>
C1 MOP	Compressor stop caused by high evaporation temperature.	<ul style="list-style-type: none"> <li>Reset the alarm so that the compressor can start again.</li> <li>During compressor operation, ensure that the expansion valve regulates the overheating to its setpoint.</li> </ul>
C1 low suction temp	Low suction gas temperature.	<ul style="list-style-type: none"> <li>Reset the alarm.</li> <li>In the event of recurring errors, contact authorised service personnel.</li> </ul>
Leakage of refrigerant in the compressor compartment	Refrigerant has been detected in the exhaust air heat pump's compressor compartment.	The unit's fan will automatically start provided that the "Service switch" is in the "Auto" position. Call certified refrigeration technician.
Alarm detector supply air, Busoffl	No communication with the detector.	Check/replace detector.

## 8.3 Carel alarm



Leak checks and replacement of parts in the refrigerant circuit must be carried out by a certified refrigeration technician. See "[1.9 Handling of refrigerant](#)", on page 11 and "[7 Checking and registering the refrigerant circuit](#)", on page 31.

Alarm code	Possible cause	Measure
AL 59 Compr 1, Low Cond Temp"	Condensing temperature too low due to: <ul style="list-style-type: none"> <li>too low exhaust air temperature.</li> <li>too low exhaust air flow.</li> <li>skewed flows.</li> </ul>	Make sure that: <ul style="list-style-type: none"> <li>the exhaust air is the correct temperature.</li> <li>the airflows are correct.</li> </ul>
94 Drive offline	Supply voltage missing.	Connect supply voltage (3×400 V).
118 Compr 1, Low evaporation pressure	Low evaporation temperature or low pressure in circuit 1.	Ensure that there are no leaks in the cooling circuit.
120 Compr 1, Low pressure diff."	No pressure difference between high pressure and low pressure side.	Contact a service technician.
121 Compr 1, High pressure switch	High pressure switch tripped in circuit 1.	Ensure that the airflow is correct and that the fire damper is working.
180 Compr 1, High pressure switch	High pressure switch tripped in circuit 1.	Make sure that: <ul style="list-style-type: none"> <li>the airflow is correct.</li> <li>fire damper works.</li> </ul>



# Operation and maintenance EcoHeater

IV Produkt's order portal

## 9 Troubleshooting



Leak checks and replacement of parts in the refrigerant circuit must be carried out by a certified refrigeration technician. See "[1.9 Handling of refrigerant](#)", on page 11 and "[7 Checking and registering the refrigerant circuit](#)", on page 31.

### 9.1 Climatix display - status message

Unit > Heat pump > Heat pump status

Symptom	Status	Possible cause	Measure
Compressor does not start	OFFbyKey	Menu in Carel™ "On/Off Unit" is not set to ON.	Set  to ON.
	OFFbyDIN	Interlock from Climatix is missing.	Set the SERVICE SWITCH to "Auto" position.
	UnitOn	Demand signal is lower than 10% (menu in Climatix "Heating demand").	Check external control 0 – 10 VDC, heating curve and outdoor air temperature sensor.
		Compressor start delay has not counted down to 0.	Wait or quick start.
	FrostTemp	The difference between the exhaust air temperature and the extract air temperature is greater than 3°C (menu "End defrostdiff").	Wait until the exhaust air temperature has risen to the starting level. Quick start.
		The exhaust air temperature is lower than 12°C (menu "End temp min freq:").	Wait for the exhaust air temperature to rise.
		The evaporation temperature or exhaust air temperature has fallen below its respective minimum temperature at the compressor's lowest possible speed.	Check that the airflow is not too low.
	Low water flow	Water flow through the exhaust air heat pump is too low.	Check that the circulation pump heat pump CP1 is running.
Check that the water flow is in the correct direction.			

# Operation and maintenance EcoHeater



---

Symptom	Status	Possible cause	Measure
The compressor speed is reduced.	HiPress	Water flow through the heat pump is too low.	Adjust the water flow.
		High return water temperature to the heat pump.	Check the incoming water temperature.
	FrostTemp	The compressor speed is limited to prevent frost formation on the recovery battery.	Normal condition when the exhaust air flow is not high enough to run the compressor at maximum power.



# Operation and maintenance EcoHeater

IV Produkt's order portal

## 10 DISASSEMBLE AND DECOMMISSION



### WARNING!

#### Risk of cutting.

*Sharp edges can cause cuts.*

- Use appropriate personal protective equipment when the work requires it.

00181



### WARNING!

#### Risk of serious personal injury.

*Contact with refrigerants can cause frostbite to the skin.*

- Refrigerants and parts containing refrigerants may only be handled by persons with certificates in accordance with current EU regulations for refrigerants.
- Wear appropriate protective clothing.

00331



### WARNING!

#### Risk of personal injury.

*Contact with the oil can cause skin irritations.*

- Draining oil from the compressor must only be carried out by certified persons in accordance with applicable EU regulations for refrigerants.
- Wear appropriate protective clothing.
- Wash hands and other body parts that have been in contact with the oil.

00330



### WARNING!

#### Risk of inhalation of harmful particles.

*When changing filters, particles, such as dust, may come loose from the used filter.*

- Wear a protective mask when changing filters.
- Use caution when handling used filters.
- Thoroughly clean the filter cabinet after replacement as particulate matter may become loose and remain in the cabinet.

00325

### 10.1 Material content

For more specific information about materials, see the Construction Product Declaration or contact IV Produkt.

DX coils (included in the exhaust air heat pump) contain refrigerant.

### 10.2 Dispose and recycle

Disposal and recycling must take place in an environmentally safe manner in accordance with applicable regulations in the country where the product is being disposed of. Up to 90% of the material in the unit can be recycled.

---

## 10.3 Disassemble the unit

1. Turn off all electricity and ensure that the unit is de-energised. See "[1.11 Safe shutdown of the unit](#)", on page 11.
2. Drain all refrigerant. **May only be carried out by a certified refrigeration technician.**
3. Remove covers, electrical components and filters.
4. Disassemble profiles and joints.
5. Remove hatches and remove interior insulation.
6. Sort and recycle according to current national regulations in the country where the unit is being disposed of.



# Operation and maintenance EcoHeater

IV Produkt's order portal

## 11 SERVICE SCHEDULE

For a description of the various unit parts and their functions, see the function descriptions in section "3 DESCRIPTION OF THE EXHAUST AIR HEAT PUMP", on page 13.

Service year:		Order no.:		Project name:			
Notes:				Service performed (date/signature)			
Unit part	Code	Check (see maintenance instructions in the sections below)	12 months	24 months	36 months	48 months	
Filter	ELEF	<i>"6.7 Filter maintenance", on page 24</i>					
Fan	ENF	<i>"6.8 Fan maintenance", on page 26</i>					
Damper	EMT-01	<i>"6.10 Maintenance of fire bypass section with damper (optional)", on page 30</i>					
Fire bypass section	EHP-B	<i>"6.10 Maintenance of fire bypass section with damper (optional)", on page 30</i>					
Sound attenuator	EMT-02	<i>"6.11 Sound attenuator maintenance", on page 30</i>					
Cooling circuit with Recovery Coil DX	EHP-C	<i>"6.9 Maintenance DX coil (in cooling circuit)", on page 28</i>					

# Operation and maintenance EcoHeater

---



## Feel free to contact us

---



IV Produkt AB, Sjöuddevägen 7, S-350 43 VÄXJÖ  
+46 470 – 75 88 00  
[www.ivprodukt.se](http://www.ivprodukt.se), [www.ivprodukt.com](http://www.ivprodukt.com)  
[www.ivprodukt.no](http://www.ivprodukt.no), [www.ivprodukt.dk](http://www.ivprodukt.dk), [www.ivprodukt.de](http://www.ivprodukt.de)



### Support:

Control:	+46 470 – 75 89 00, <a href="mailto:styr@ivprodukt.se">styr@ivprodukt.se</a>
Service:	+46 470 – 75 89 99, <a href="mailto:service@ivprodukt.se">service@ivprodukt.se</a>
Spare parts:	+46 470 – 75 86 00, <a href="mailto:reservdelar@ivprodukt.se">reservdelar@ivprodukt.se</a>
DU/Documentation:	+46 470 – 75 88 00, <a href="mailto:du@ivprodukt.se">du@ivprodukt.se</a>

---