



ACVATIX™

## Electromotoric actuators for valves

## SAX..

with a 20 mm stroke

- 
- **SAX31..** Operating voltage AC 230 V, 3-position control signal
  - **SAX61..** Operating voltage AC/DC 24 V, control signal DC 0...10 V, 4...20 mA
  - **SAX81..** Operating voltage AC/DC 24 V, 3-position control signal
  - **SAX61..** Position feedback, override control, choice of flow characteristic
  - For direct mounting on valves; no adjustments required
  - Manual adjuster, position indicator and status indication per LED
  - Optional functions with auxiliary switches, potentiometer, function module, stem heating element

### Use

---

For the operation of Siemens 2-port and 3-port valves, types V..F21.., V..F31.., V..F40.., V..F41.., V..G41.., VVF52.. and V..F53.. with 20 mm stroke as control and safety shut-off valves in heating, ventilation and air conditioning systems.

## Type summary

Product no.	Stock no.	Stroke	Pos. force	Operating voltage	Positioning signal	Spr. ret. time	Pos. time	LED	Manual adjuster	Extra functions	
<b>SAX31.00</b>	S55150-A105	20 mm	800 N	AC 230 V	3-Punkt	-	120 s	-	Push and fix	-	
<b>SAX31.03</b>	S55150-A106			AC/DC 24 V	DC 0...10 V DC 4...20 mA 0...1000 Ω		3-Punkt	30 s		✓	Position feedback, forced control, change of characteristic
<b>SAX61.03</b> <b>SAX61.03U</b>	S55150-A100 S55150-A100-A100							120 s		-	-
<b>SAX81.00</b> <b>SAX81.00U</b>	S55150-A102 S55150-A102-A100			30 s	-		-				
<b>SAX81.03</b> <b>SAX81.03U</b>	S55150-A103 S55150-A103-A100			30 s	-		-				

## Electrical accessories

Product no.	Auxiliary switch <b>ASC10.51</b>	Potentiometer <b>ASZ7.5/..</b> <sup>1)</sup>	Function module <b>AZX61.1</b>	Stem heating element <b>ASZ6.6</b>
Stock no.	S55845-Z103	S55845-Z104 (ASZ7.5/135) S55845-Z105 (ASZ7.5/200) S55845-Z106 (ASZ7.5/1000)	S55845-Z107	S55845-Z108
		Max. 2		Max. 1
<b>SAX31..</b>	Max. 2	Max. 1	-	Max. 1
<b>SAX61..</b>	Max. 2	-	Max. 1 AZX61.1	
<b>SAX81..</b>		Max. 1	-	

<sup>1)</sup> Available with 135 Ω, 200 Ω or 1000 Ω

## Mechanical Accessory

Weather shield ASK39.1

## Ordering



### Example

Product no.	Stock no.	Description	Quantity
SAX81.03	S55150-A103	Actuator	1
ASZ7.5/1000	S55845-Z106	Potentiometer	1

### Delivery

Actuators, valves and accessories are supplied in individual packs.

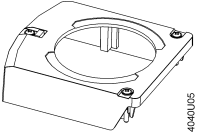
### Spare parts

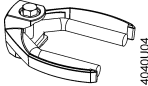
Product number / Stock number	Description	Image
8000060843	Housing cover	
	Screw (valve stem coupling)	
	U-bracket	

## Combinations

Type reference		DN	PN class	$k_{vs}$ [m <sup>3</sup> /h]	Data sheet
<b>2-port valves VV.. (control or safety shutoff valves)</b>					
VVF21..	flange	25...80	6	1.9...100	N4310
VVF31..	flange	15...80	10	2.5...100	N4320
VVF40..	flange	15...80	16	1.9...100	N4330
VVF41..	flange	50		19 / 31	N4340
VVG41..	thread	15...50	25	0.63...40	N4363
VVF52..	flange	15...40		0.16...25	N4373
VVF53..	flange	15...50		0.16...40	N4405
<b>3-port valves VX.. (control valves for "mixing" and "diverting" functions)</b>					
VXF21..	flange	25...80	6	1.9...100	N4410
VXF31..	flange	15...80	10	2.5...100	N4420
VXF40..	flange	15...80	16	1.9...100	N4430
VXF41..	flange	15...50		1.9...31	N4440
VXG41..	thread		1.6...40	N4463	
VXF53..	flange	15...50	25	1.6...40	N4405

## Product documentation

Detailed Informations about the New Generation actuators can be found in the Basic documentation "Electromotoric actuators SAX.." (CE1P4040\_01en).

## Notes

### Engineering

SAX31.. and SAX81..

3-position actuators must have their own specific controller, refer to "Connection Diagrams" (page 7).

SAX61..

Up to 10 actuators can drive in parallel on a controller output with a rating of 1 mA. Modulating actuators have an input impedance of 100 kΩ.

## Mounting

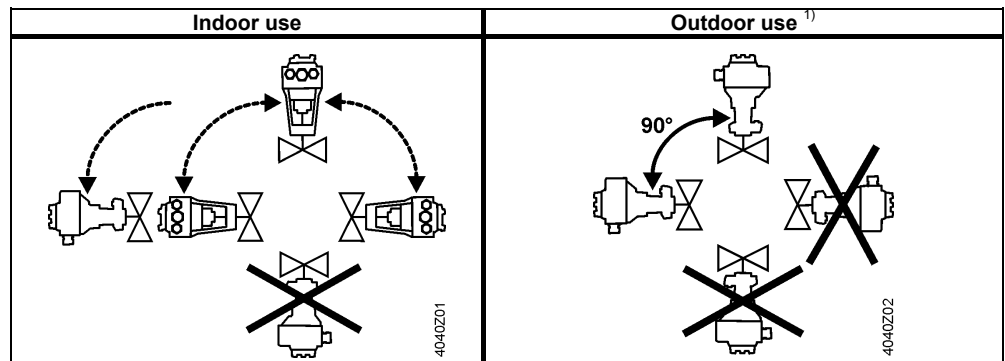

<sup>1)</sup> Only in connection with weather shield ASK39.1

## Maintenance

The actuators are maintenance-free.

## Warranty

The engineering data specified in chapter "Combinations" (page 3) are only guaranteed in connection with the Siemens valves listed.

## Note

**When using the actuators in connection with valves of other manufacture, correct functioning must be ensured by the user, and Siemens will assume no responsibility.**

## Technical Data

		SAX..
<b>Power supply</b>	Operating voltage SAX31.. SAX61.. SAX81..	AC 230 V ±15% AC 24 V ± 20% / DC 24 V + 20% / -15% AC 24 V ±20% / DC 24 V + 20 % / -15%
	Frequency	45...65Hz
	Fusing of supply lines	Max. 10 A slow
	Power consumption at 50 Hz	
	SAX31.00 Stem retracts / extends SAX31.03 Stem retracts / extends SAX61.03.. Stem retracts / extends SAX81.00.. Stem retracts / extends SAX81.03.. Stem retracts / extends	3.5 VA / 2 W 8 VA / 3.5 W 8 VA / 3.75 W 3.5 VA / 2.25 W 8 VA / 3.75 W
<b>Function data</b>	Positioning times (with the specified nominal stroke) The positioning time can vary, depending on the type of valve -> refer chapter "Type summary" (page 2) SAX31.00, SAX81.00.. SAX31.03, SAX61.03.., SAX81.03..	120 s 30 s
	Positioning force Nominal stroke Permissible medium temperature (valve fitted)	800 N 20 mm -25...150 °C
<b>Signal inputs</b>	Positioning signal "Y" SAX31.., SAX81.. SAX31.. Voltage SAX81.. Voltage SAX61.. (DC 0...10 V) Current draw SAX61.. (DC 4...20 mA) Current draw	3-position AC 230 V ±15% AC 24 V ± 20 % / DC 24 V + 20 % / -15% ≤ 0.1 mA ≥100 kΩ DC 4...20 mA ± 1%
		Input impedance ≤500 Ω
<b>Parallel operation</b>	SAX61..	≤ 10 (depending on controller output)
<b>Forced control</b>	Positioning signal "Z" SAX61.. R = 0...1000 Ω Z connected to G Z connected to G0 Voltage Current draw	R = 0...1000 Ω, G, G0 Stroke proportional to R Max. stroke 100% <sup>1)</sup> Min. stroke 0% <sup>1)</sup> Max. AC 24 V ± 20% Max. DC 24 V + 20% / -15% ≤ 0.1 mA
<b>Position feedback</b>	Position feedback U SAX61.. Load impedance Load	DC 0...10 V ± 1% >10 kΩ res. Max. 1 mA
<b>Connecting cable</b>	Wire cross-sectional areas	0.13...1.5 mm <sup>2</sup> , AWG 24...16 <sup>2)</sup>
	Cable entries SAX.. SAX..U	EU: 2 entries Ø 20.5 mm (for M20) 1 entry Ø 25.5 mm (for M25) US: 3 entries Ø 21.5 mm for ½" tube connection
<b>Degree of protection</b>	Housing from vertical to horizontal	IP54 as per EN 60529 <sup>3)</sup>
	Insulation class Actuators SAX31.. AC 230 V Actuators SAX61.. AC / DC 24 V Actuators SAX81.. AC / DC 24 V	As per EN 60730 II III III
<b>Environmental conditions</b>	Operation Climatic conditions Mounting location Temperature General with spindle heating element ASZ6.6 Humidity (noncondensing)	IEC 60721-3-3 Class 3K5 Indoors (weather-protected) -5...55 °C -15...55 °C 5...95% r.h.
	Transport Climatic conditions Temperature Humidity	IEC 60721-3-2 Class 2K3 -25...70 °C <95% r.h.
	Storage Temperature Humidity	IEC 60721-3-1 -15...55 °C 5...95% r.h.
	Max. media temperature when mounted on valve	150 °C
<b>Standards</b>	CE conformity As per EMC directive Immunity Emissions	2004/108/EC EN 61000-6-2:[2005] Industrial <sup>4)</sup> EN 61000-6-3:[2007] Residential
	Electrical safety	EN 60730-1
	Low-voltage directive AC 230 V	2006/95/EC
	C-tick	N 474
	UL conformity AC 230 V AC/DC 24 V	- UL 873

		SAX..
Environmental compatibility		ISO 14001 (environment) ISO 9001 (quality) SN 36350 (environment-compatible products) RL 2002/95/EG (RoHS)
Dimensions		See "Dimensions" (page 8)
Accessories	Potentiometer ASZ7.5/135	0...135 Ω ± 5% DC 10 V Current rating <4 mA
	Potentiometer ASZ7.5/200	0...200 Ω ± 5% DC 10 V Current rating <4 mA
	Potentiometer ASZ7.5/1000	0...1000 Ω ± 5% DC 10 V Current rating <4 mA
	Auxiliary switch ASC10.51	Switching capacity AC 24...230 V, 6 A res., 3 A ind.
	Stem heating element ASZ6.6	AC 24 V, 30 W

<sup>1)</sup> Observe acting direction of DIL switches

<sup>2)</sup> AWG = American wire gauge

<sup>3)</sup> Also with weather shield ASK39.1

<sup>4)</sup> Transformer 160 VA (e.g. Siemens 4AM 3842-4TN00-0EA0) for actuators operating on AC 24 V

## Connection Diagrams

### Internal Diagrams

SAX31..

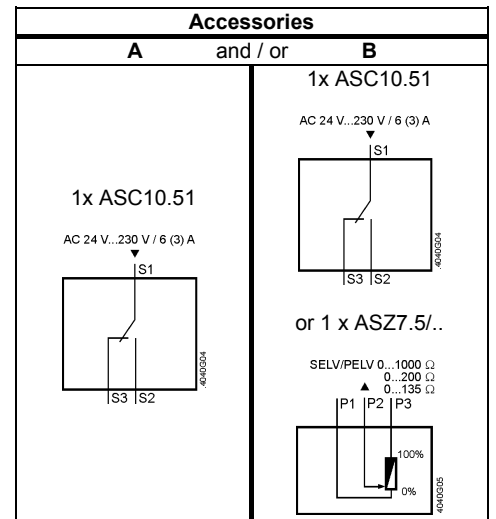
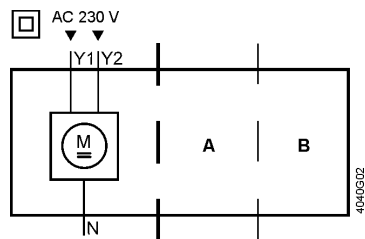

SAX61..

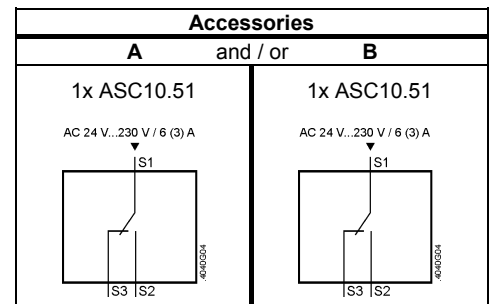
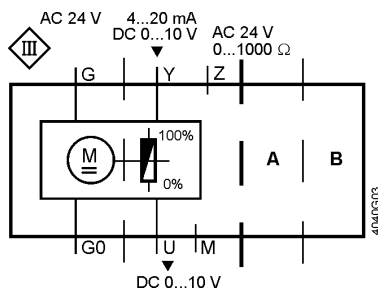

SAX81..

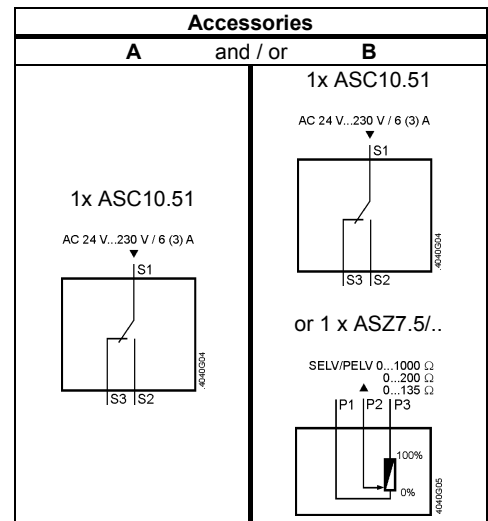
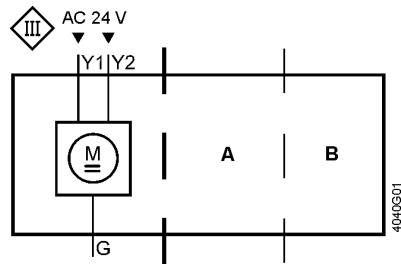

### Connection terminals

SAX31..

AC 230 V, 3-position

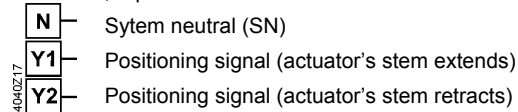

SAX61..

AC/DC 24 V, DC 0...10 V / 4...20 mA / 0...1000 Ω

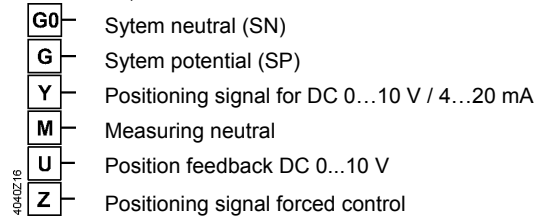

SAX81..

AC/DC 24 V, 3-position

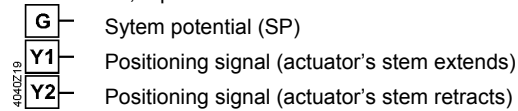

**Connection Diagrams**  
SAX31..

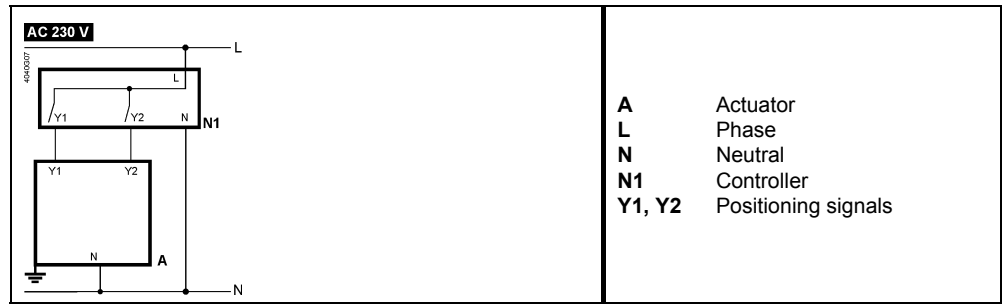

SAX61..

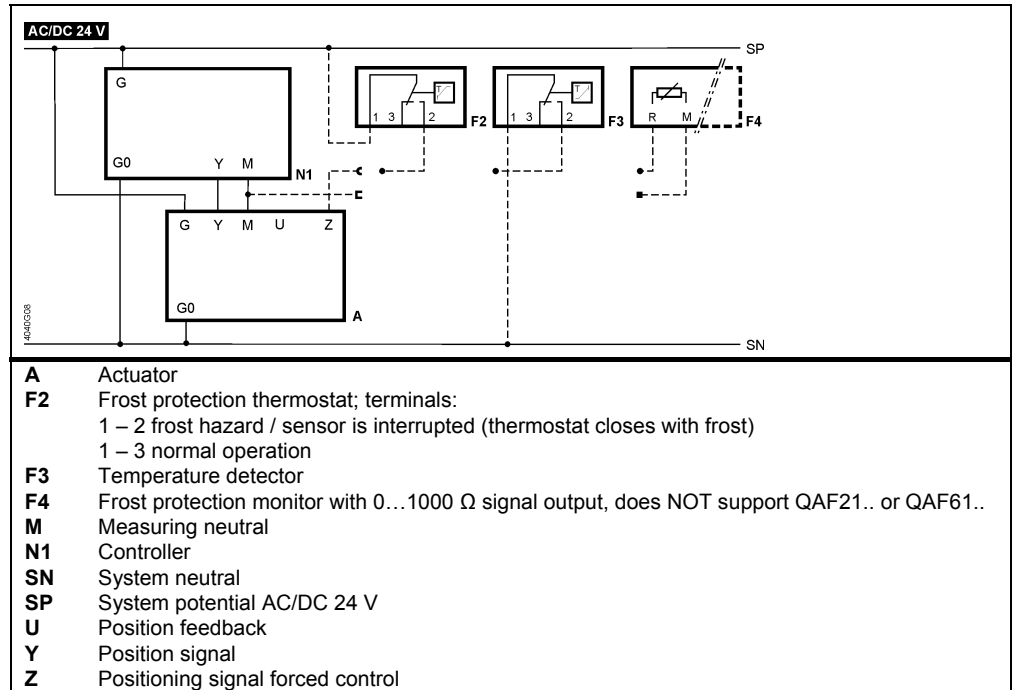

SAX81..

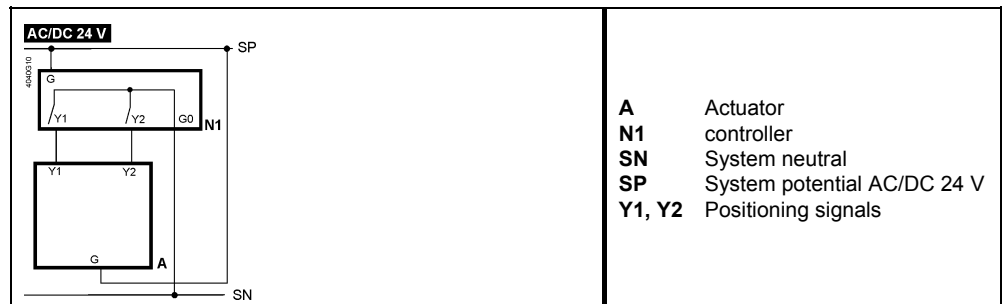

## Dimensions

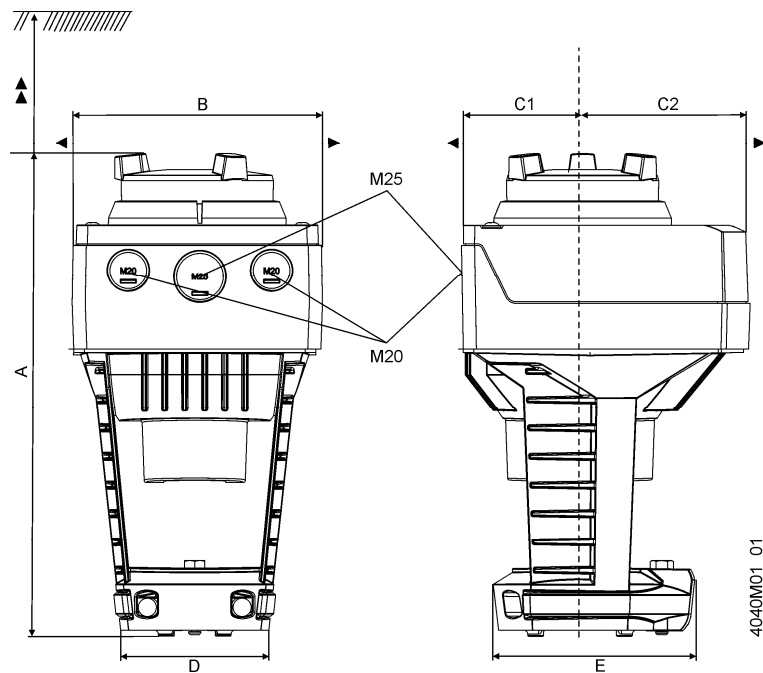

Product no.	A	B	C	C1	C2	D	E	▶	▶▶
SAX..(U <sup>1)</sup> )	242	124	150	68	82	80	100	100	200
With ASK39.1	+25	154	300	200	100	-	-	-	-

Dimensions in mm

<sup>1)</sup>SAX..U: For 1/2" tube connections (21.5 mm dia.)

## Revision numbers

Product no.	Valid from rev. no.
SAX31.00	..A
SAX31.03	..A
SAX61.03..	..A
SAX81.00..	..A
SAX81.03..	..A